



**Installation and Maintenance
Instructions for GC31
Ultra-Compact Digital
Pressure Sensor**



CONTENTS

CAUTION	4
1. SPECIFICATIONS	5
2. DIMENSION DRAWINGS	6
3. INSTALLATION.....	6
4. WIRING	7-8
5. NOISE PREVENTION	9
6. STORAGE	9
7. MAINTENANCE	9
8. MENU NAVIGATION	9-10
9. FUNCTION SETTING MODE	10-12
10. SWITCH SETTING MODE	12-13
11. SWITCH OPERATION	14-15
12. OTHER FUNCTIONS	15
13. ERROR DISPLAY	16
14. MAINTENANCE & WARRANTY	17



WARNING! READ BEFORE INSTALLATION



1. GENERAL:

A failure resulting in **injury** or **damage** may be caused by excessive overpressure, excessive vibration or pressure pulsation, excessive instrument temperature, corrosion of the pressure containing parts, or other misuse. Consult Ashcroft Inc., Stratford, Connecticut, USA before installing if there are any questions or concerns.

2. OVERPRESSURE:

Pressure spikes in excess of the rated overpressure capability of the transducer may cause **irreversible electrical and/or mechanical damage** to the pressure measuring and containing elements.

Fluid hammer and surges can destroy any pressure transducer and must always be avoided. A pressure snubber should be installed to eliminate the damaging hammer effects. Fluid hammer occurs when a liquid flow is suddenly stopped, as with quick closing solenoid valves. Surges occur when flow is suddenly begun, as when a pump is turned on at full power or a valve is quickly opened.

Liquid surges are particularly damaging to pressure transducers if the pipe is originally empty. To avoid damaging surges, fluid lines should remain full (if possible), pumps should be brought up to power slowly, and valves opened slowly. To avoid damage from both fluid hammer and surges, a surge chamber should be installed.

Symptoms of fluid hammer and surge's damaging effects:

- Pressure transducer exhibits an output at zero pressure (large zero offset).
- Pressure transducer output remains constant regardless of pressure
- In severe cases, there will be no output.

FREEZING:

Prohibit freezing of media in pressure port. Unit should be drained (mount in vertical position with electrical termination upward) to prevent possible overpressure damage from frozen media.

3. STATIC ELECTRICAL CHARGES:

Any electrical device may be susceptible to damage when exposed to static electrical charges. To avoid damage to the transducer observe the following:

- Ground the body of the transducer **BEFORE** making any electrical connections.
- When disconnecting, remove the ground **LAST!**

Note: The shield and drain wire in the cable (if supplied) is not connected to the transducer body, and is not a suitable ground.

4. USE IN LIFE SUPPORT DEVICES

Ashcroft Inc. products are not authorized for use as critical components in life support devices or systems without the express written approval of the General Manager, Stratford Operations of Ashcroft Inc. As used herein:

1. Life support devices or systems are devices or systems which, (a) are intended for surgical implant into the body, or (b) support or sustain life, and whose failure to perform, when properly used in accordance with instructions for use provided in the labeling, can be reasonably expected to result in a significant injury to the user.
2. A critical component is any component of a life support device or system whose failure to perform can be reasonably expected to cause the failure of the life support device or system, or to affect its safety or effectiveness.

1. SPECIFICATIONS:

PERFORMANCE SPECIFICATIONS

Analog Output (1–5Vdc):

Accuracy: $\pm 1.0\%$ FS (Accuracy includes the effects of Linearity, Hysteresis and Repeatability)
Response Time: 50msec
Output Resolution: 25mV
Analog Scaling: User may configure analog output scaling to any range within Full Scale of sensor range

Pressure Switch Output:

Type: NPN or PNP Open Collector up to 30Vdc/80mA
Setting Accuracy: $\pm 1.0\%$ FS
Number of Contacts: 2
Response Time: 5msec-2.0 sec (by user)
Hysteresis: Variable (by user)
Switch Setting: User may adjust switch actuation & deadband to any points within Full Scale sensor range

Display:

Type: 3½ digit, 10mm LED
Accuracy: $\pm 1.0\%$ FS \pm last digit
Display Setting: User may re-configure display scaling, set to capture MIN or MAX value, and adjust display update rate

Standard Ranges (Gauge):

0 to 50psig, 100psig, 150psig, 300psig, 500psig, 1000psig, 1500psig

Standard Ranges (Compound):

-15 to 15psig, -15 to 75psig, -15 to 150psig, -15 to 300psig

ENVIRONMENTAL SPECIFICATIONS

Temperature Limits:

Storage: -30 to 60°C (-22 to 140°F)
Operating: -20 to 60°C (-4 to 140°F)
Compensated: -10 to 50°C (14 to 122°F)
Temperature Effects:
Zero/Span: $\pm 0.05\%$ FS/°C (from 23°C (-73°F) reference temperature)

Humidity: 0-85% RH (Non-Condensing)

FUNCTIONAL SPECIFICATIONS

Proof Pressure: 2X Range
Burst Pressure: 10X Range
CE Compliance: EN61326-1 2006, EN61326-2-3 2006

ELECTRICAL SPECIFICATIONS

Power Supply Requirements:

Supply Voltage: 11-27Vdc
Current Consumption: 30mA (max)
Switch Contacts: (2) NPN or PNP Open Collector Outputs
NPN Type: 30Vdc/80mA (max)
PNP Type: Sensor Supply Voltage/80mA (max)

MECHANICAL SPECIFICATIONS

Pressure Connection: ¼ NPT Male, G¼B (Opt.)

Enclosure: ABS, Polycarbonate, Aluminum

Rating: IP40

Electrical Connection: 6ft Cable Pigtail

Weight: Approx. 120 grams

Mounting: Panel Mounting Bracket included (Back Connect Only)

Media: Fluids and gases compatible with 304SS (sensor housing) and 17-4 pH SS (sensor diaphragm)

2. PRODUCT DIMENSIONS

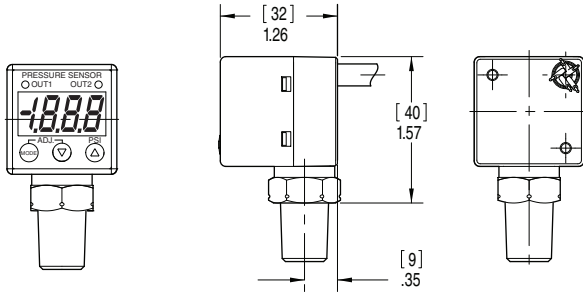
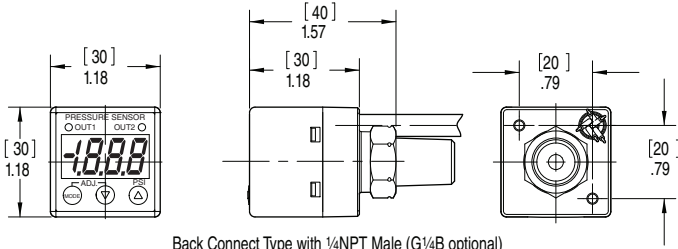
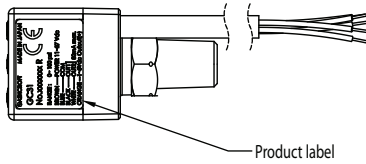

PROCESS CONNECTIONS

1/4NPT Male Standard

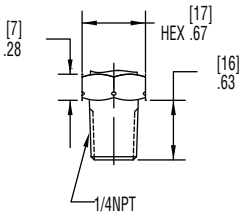

G1/4B (PF) Optional

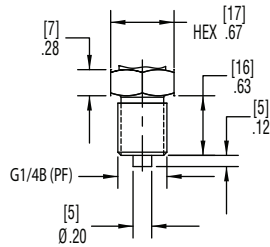

3. INSTALLATION

Install in a location where vibration and shock can be minimized and without direct sunlight on the display in compliance with IP40 environmental rating.
 (Pressure port connection: ¼NPT male 1½ turns hand tighten.)

Note: Panel mount adapter for back connection only. Do not attach panel mount adapters prior to panel installation or out of sequence as stated below.

- 1.) Take Panel Adapter #1 (tube notch faced down) and mount to the main body with panel placed in between as pictured. Push adapter and main body together until tabs engage notches.
- 2.) Take Panel Adapter #2 (tube notch faced down) and attach to the back of the main body. Push until panel adapter tabs engage the main body notches.
- 3.) Gently push panel adapters together until gaps are minimized.

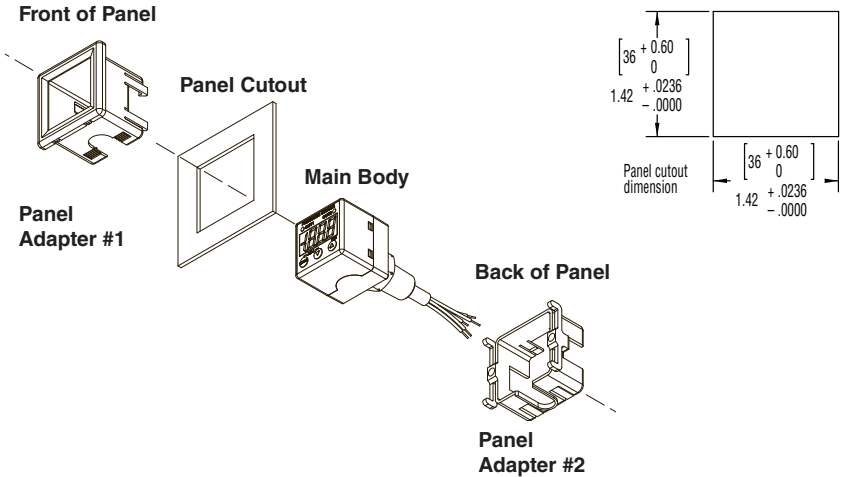

4. WIRING

Cable wire colors are shown below. Power on after checking connections. when on wait at least 5 minutes before performing a zero point adjustment or measurement to ensure system is stabilized.

- | | |
|-------------|---------------------------------|
| Brown..... | Power (+) |
| Blue..... | Power (-)/COM |
| Orange..... | Analog output (+) |
| Black..... | Open collector output OUT 1 (+) |
| White..... | Open collector output OUT 2 (+) |

Analog Output (1-5VDC)

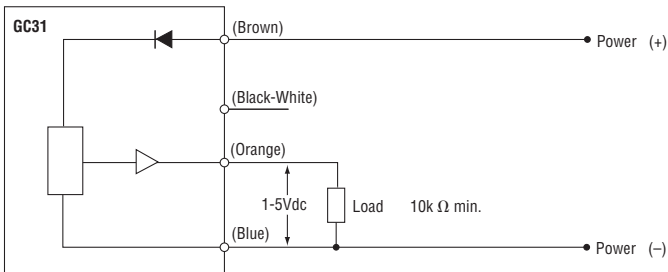

NPN Type Switch Function (wiring to relay)

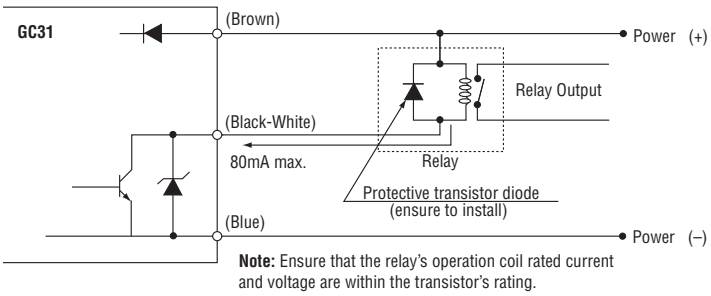

NPN Type Switch Function (wiring to photocoupler)

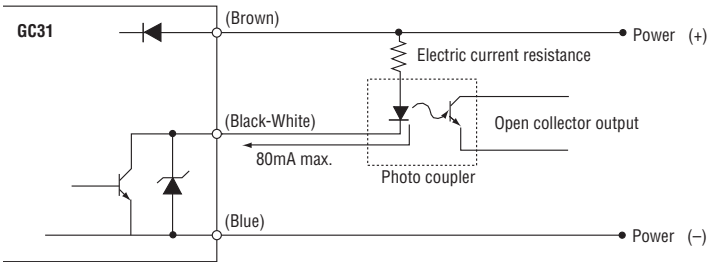

NPN Type Switch Function (voltage output)

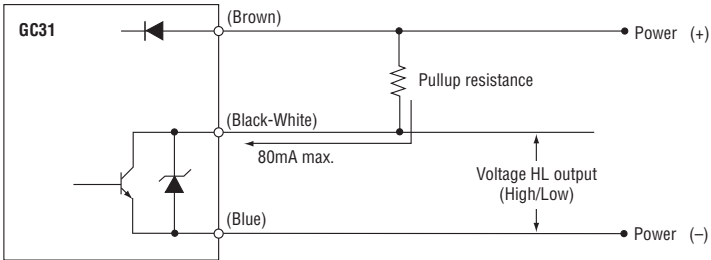

PNP Type Switch Function (wiring to relay)

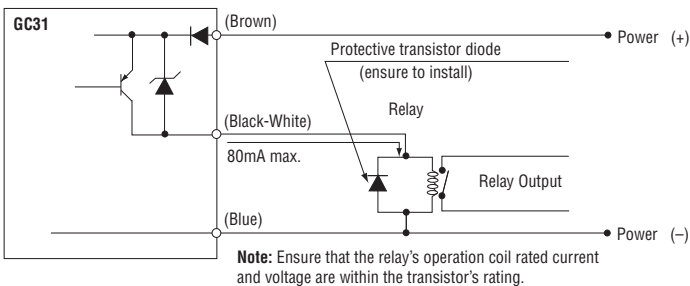

PNP Type Switch Function (wiring to photocoupler)

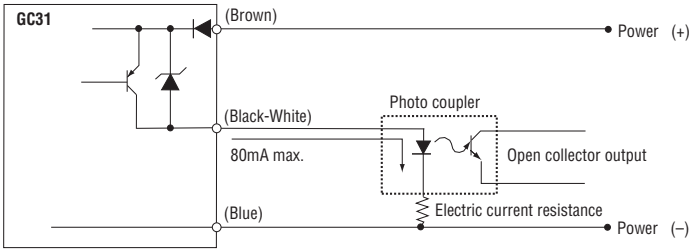

PNP Type Switch Function (voltage output)

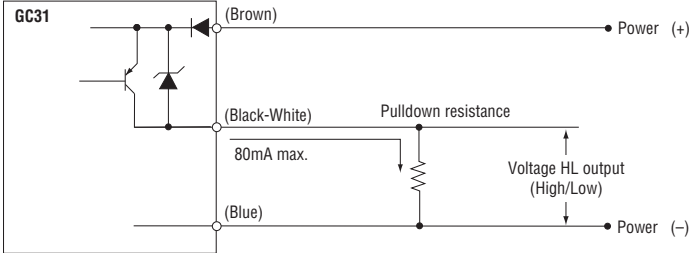

5. NOISE PREVENTION

Power Supply

The pressure display can fluctuate and provide incorrect output if noise is present in the power supply/wire. Care should be taken to keep the GC31 power supply wires from high voltage lines and use a power line with a high noise rejection ratio.

6. STORAGE

Store in a location in compliance with the environmental rating of the unit and within -30 to +60C (-22 to 140F). Avoid direct exposure of the display to Sunlight.

7. MAINTENANCE

Although this is a solid state device, it is recommended that a visual inspection be conducted twice a year along with regular zero adjustment if necessary.

8. MENU NAVIGATION

Functions

PLEASE NOTE: Do not use sharp objects to press the keys as this can puncture the panel. See illustration for External Panel and Functions.

Comparator/Switch Output Status LED

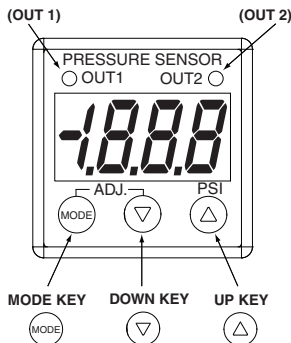

Pressing the **(MODE)** key for 3 seconds displays “---”. To return to measurement mode from each setting mode, the “---” display will flash when 3 seconds have passed.

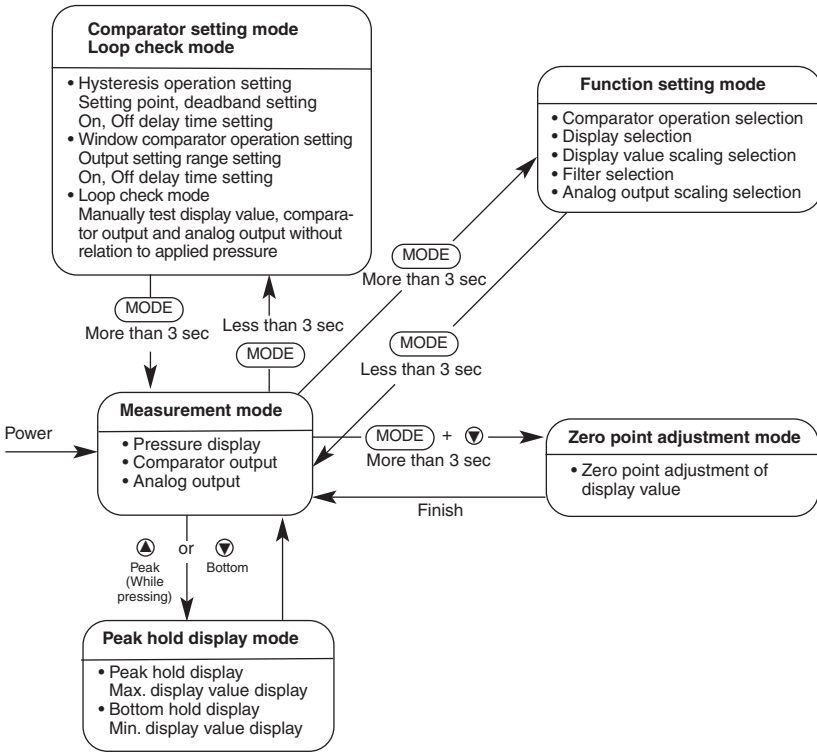

9. FUNCTION SETTING MODE

Setup Steps

Pressing the **(MODE)** key for 3 seconds displays “---” to return to measurement mode from each setting mode, the “---” display will flash when 3 seconds has passed. The setting mode is used to select switch operation, pressure unit indication scaling, scaling of analog output and filter time constant.

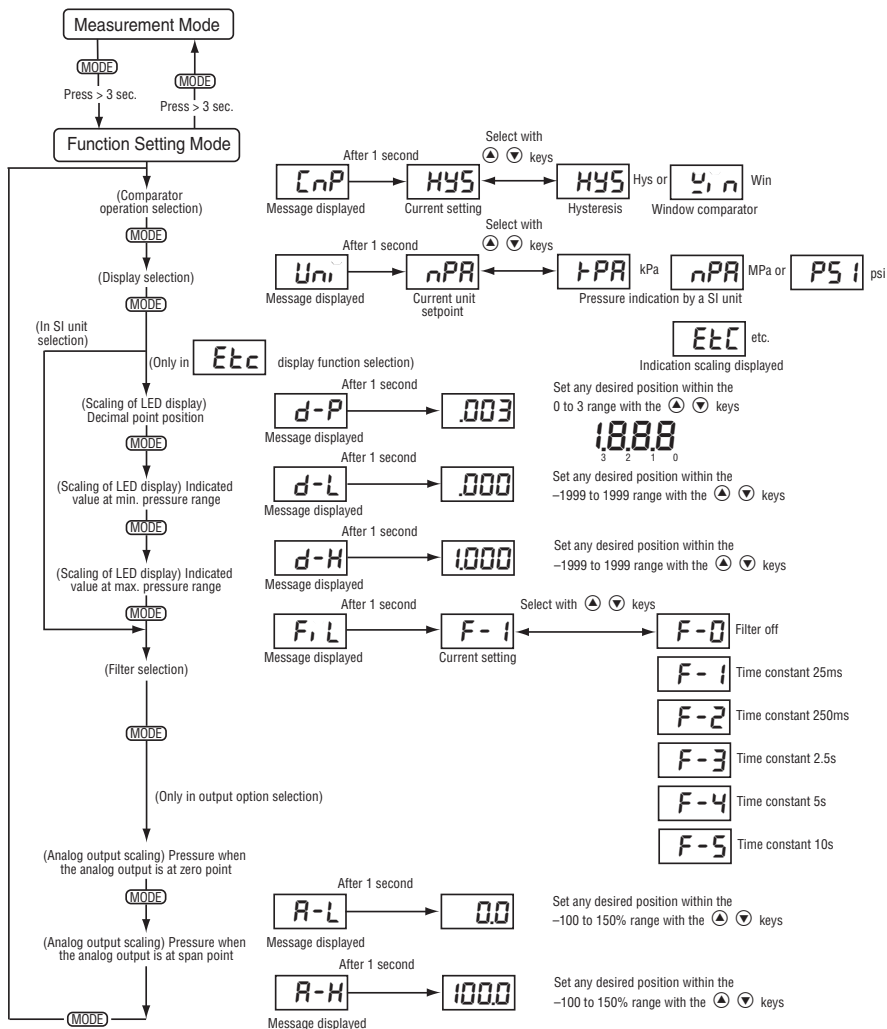

Caution: Editing the setting value in function setting mode resets all of the setting values including the switch. Please note that when the reset setting values are out of the display range, they will be adjusted to an upper or lower limit value that can be processed internally.

9A. SWITCH OPERATION

Select "Switch Operation Selection" with the (MODE) key. The message [CnP] is displayed for 1 sec. and then the current setting is displayed. Select either hysteresis or switch operation display with the ▲ ▼ keys.

9B. DISPLAY SELECTION

Select "Display Selection with the (MODE) key. The message displayed for 1 sec. and then the current setting is displayed. Select pressure display by PSI or display scaling (Arbitrary unit defined by user) with the keys.

9C. SELECTING STANDARD OR CUSTOM SCALING MODE

When the $\boxed{E\&L}$ is selected in "Display Selection", the display value of pressure for applied pressure displays as an arbitrary scaling display. This is a function to scale the MIN/MAX display value and has NO effect on applied pressure and analog output.

9D. CUSTOM SCALING MODE

Use the \boxed{MODE} key to set "Decimal point position", "Minimum pressure range display value" and "Maximum pressure range display value" of "Display scaling".

Example: With a pressure range of 0 to 150 psi (0 to 100% FS), main unit display of 000.0 to 150.0 (factory set) is changed to a display of 0.000 to 1.000. (User defined unit, in this case 1MPa)

$\boxed{d-P}$	Dec. point position (from least significant digit):	0.1	.003
$\boxed{d-L}$	Min. pressure range value:	0.0	.000
$\boxed{d-H}$	Max. pressure range value:	150.0	1.000

9E. FILTER SECTION

The GC31 is equipped with 5 internal time constant filters. Use this function when pressure fluctuations can result in erratic, difficult to read displays. The time constant for the selected filters reflects on the switch outputs as well as the analog output.

Select "Filter Selection" with the \boxed{MODE} key. The message $\boxed{F-i}$ is displayed for 1 sec. and then the current setting mode's decimal point position is displayed. Change the decimal point position value with the \blacktriangle \blacktriangledown keys.

Entering the setting value in function setting mode resets all of the setting

$\boxed{F-0}$	No filter
$\boxed{F-1}$	Time constant 25ms
$\boxed{F-2}$	Time constant 250ms
$\boxed{F-3}$	Time constant 2.5 sec
$\boxed{F-4}$	Time constant 5 sec
$\boxed{F-5}$	Time constant 10 sec

9F. ANALOG OUTPUT SCALING

This mode is for setting the pressure for the analog output zero point and span point. Display by analog selection is scaled as 0 to 100% (Zero point: 1Vdc, span: 5Vdc). Select "Analog Scaling" with the MODE key.

The message $\boxed{R-L}$ is displayed for 1 sec. and the current pressure's analog output zero point (1Vdc) is displayed as a percentage. Change the numeric value with the \blacktriangle \blacktriangledown keys.

The message $\boxed{R-H}$ is displayed for 1 sec. and the analog output span point's pressure can be set in the same way using the \blacktriangle \blacktriangledown keys.

Example: With Analog output of 1 to 5Vdc at pressure range of 0 to 100 psi (0 to 100% FS), output is changed to 1 to 5Vdc at 0 to 90 psi.

Set the analog output zero point: 0.0% FS 0.0% FS (1Vdc output with pressure range 0% FS).

Set the analog output span point: 100.0% FS 90% (5Vdc output with pressure range 90% FS).

10. SWITCH SETTINGS MODE

Setup Steps

In Measurement Mode press the key (release within 3 sec.) to change to Switch Setting Mode.

Switch Setting Mode

There are two switches, OUT1 and OUT2. Both "Hysteresis (upper/lower limit)" and "Window Comparator" operations can be selected in the function setting mode (switch operation selection). Those two operations can be selected at once, and can be set. Both OUT1 and OUT2 can be set independently to a max on/off delay of 2 seconds. In the following explanation, if the switch's output conditions are met their output state will become On, and "Switch LED (OUT1, OUT2)" will light up.

NOTE: if the switch's setting value is set outside the display range, the switch's setting value can be rewritten automatically by the function setting mode operation.

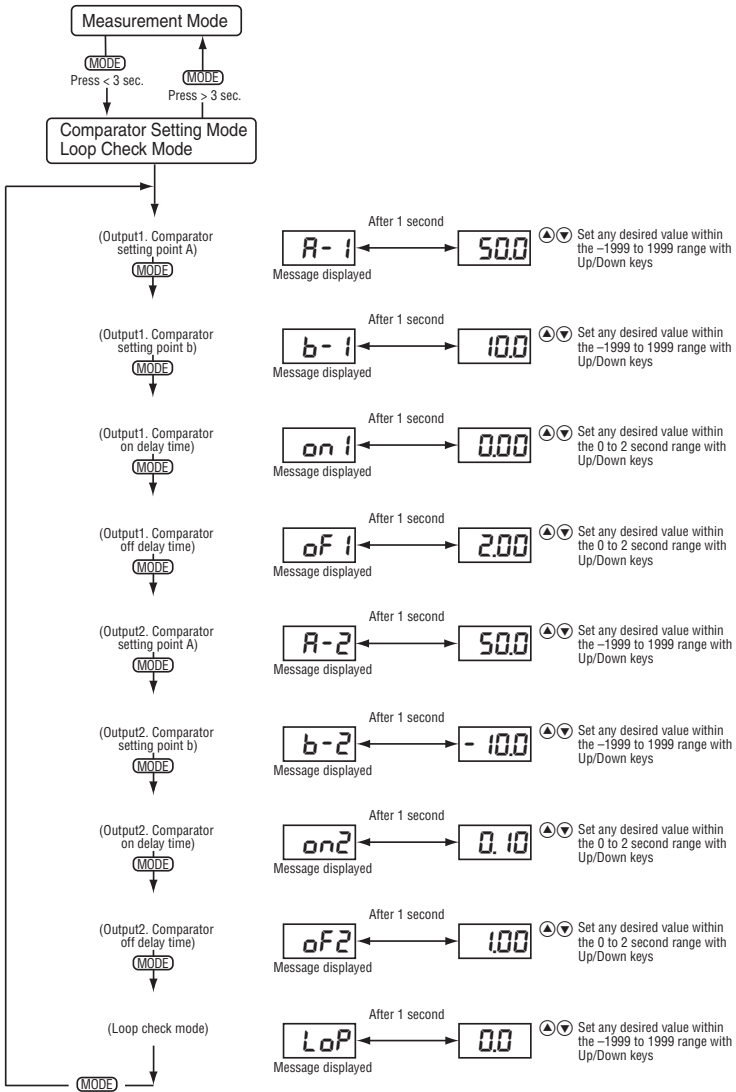

11. SWITCH OPERATION – HYSTERESIS/DEADBAND

Setting the upper limit

This is the mode in which the switch operates with the setting value (A) as the upper limit. The upper limit setting is determined when you select a positive number (including 0) for setting value (b).

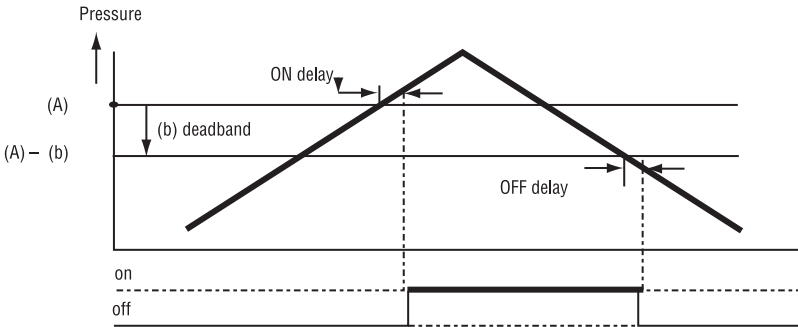

Setting the lower limit

This is the mode in which the switch operates with the setting value (A) as the lower limit. The lower limit setting is determined when you select a negative number for setting value (b).

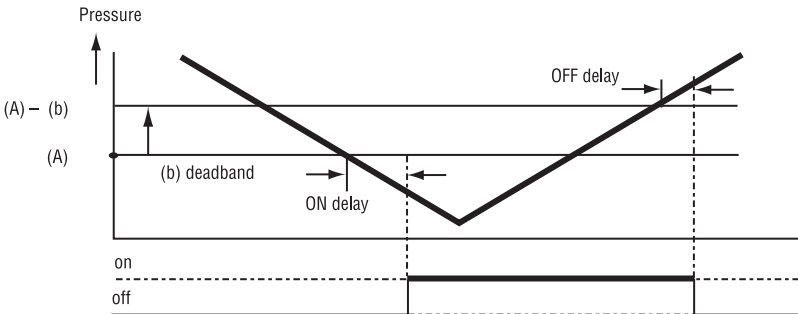

- For $(A) \cong (b)$

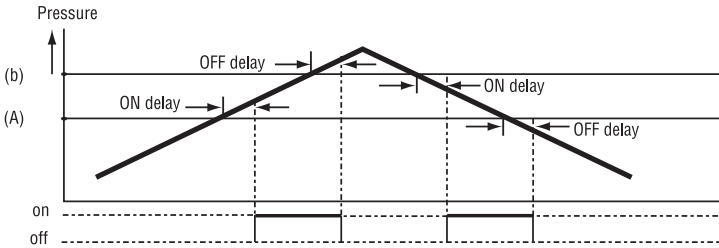

- For $(A) > (b)$

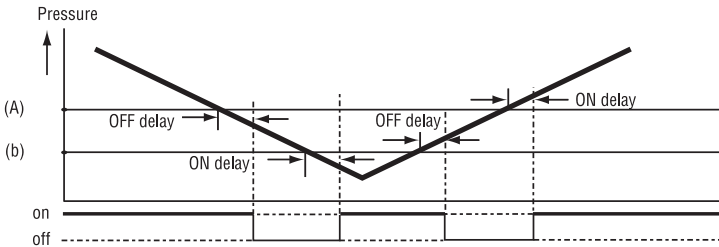

The 1% F.S. deadband is automatically set internally for setting point (A) and (b).

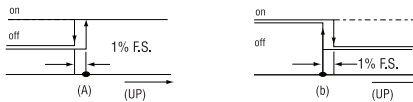

Loop check function

At the end of the Switch Operation Menu is the Loop Check function. Using the **(MODE)** key to select the Loop Check function. After **[L o P]** is displayed for 1 second, the value of the latest measurement mode is displayed as default. Use **▲ ▼** keys to set displayed value anywhere between -1999 and 1999 to confirm switch operations and/or analog output operation.

12. OTHER FUNCTIONS

Basic Key Operations

In all setting modes, values are set with the **▲ ▼** keys. Use the **▲** key to increase and the **▼** key to decrease the value. A repeat state occurs in three phases of speed when the **▲ ▼** keys are pressed for more than 0.5 seconds to increase or decrease numerical value. **▲ ▼** keys are also used for setting switch, unit and filter in the function setting mode.

Re-Zero of Sensor

In measurement mode, select display to adjust zero using key. Press **(MODE) + ▼** keys for more than 3 second (until "----" display blinks) after releasing pressure from the pressure port. Automatic zero adjustment takes place approximately 1 second later for pressure display to be zero.

When the zero adjustment is successful, **[R d J]** is displayed.

Error displays **[E - 0]** for 1 second when applied pressure was outside of range of -5 to 5% FS, zero adjustment will not be allowed.

Maximum/Minimum Pressure Capture

The GC31 unit keeps the maximum and minimum pressure level applied to the pressure port as peak and bottom values respectively, in the internal memory. The peak and bottom values are displayed while holding the ▲ or ▼ keys respectively. Message PEH is displayed for one second and selected Max/Min value is displayed by this operation. Maximum and minimum values are reset when you reset power to the unit or by the following procedure:

Resetting Maximum value: While holding the ▲ key, press the ▼ key.

Resetting Minimum value: While holding the ▼ key, press the ▲ key.

13. ERROR DISPLAY

An error message and pressure value are alternately displayed when one of the following errors occurs in the measurement mode (in case of “Out of pressure display range” error, only error message is displayed). Check the content of error message and taken the action below immediately.

Error display	Contents	Actions
FFF	Out of pressure display range (Upper limit) Pressure above 110% FS of pressure had been applied, or the indicated value exceeded 1999.	Adjust the applied pressure within the rated pressure.
FFF	Out of pressure display range (Lower limit) Pressure below -10% FS had been applied, or the indicated value fell below -1999.	
E-0	Pressure applied during the zero point adjustment, was outside the range by $\pm 10\%$ FS.	Open the unit to atmosphere and perform zero point adjustment.
E-1	Comparator 1 overloaded	Drop load current below 80mA before use. Turn power on again to recover from error status.
E-2	Comparator 2 overloaded	
E 12	Comparator 1 & 2 overloaded	

14. MAINTENANCE AND WARRANTY

Periodic Inspection

Depending upon the type of use periodic inspection is recommended at least once a year. Please refer to the following items for periodic inspection.

1. Appearance
2. Display/output check via appropriate pressure standard⁽¹⁾
3. Display/output check via Loop Check⁽²⁾

CAUTION

- Avoid electrostatic charging. When cleaning this product, please use a soft, damp cloth.
- Do not use thinner, etc. which may cause deterioration and failure.

Product warranty

Except as otherwise provided, the product warranty of this product is as follows:

Period: 12 months after delivery

Warrantable defects: Defects resulting from the design and manufacture of our company, the quality of the material, etc.

Implementation of warranty: This warranty will be completed by substitution or repair of the product concerned.

Consequential damages caused by product defects are not the responsibility of the manufacturer.

- If you have any questions about this document, please contact the sales office or distributor nearest you.
- This document is subject to change without notice due to upgrade, etc.

(1) If zero correction is required refer to section 13.

(2) Loop check, see section 12.

