

Installation Instructions for ASHCROFT® Model 1132 Differential Pressure Gauge/Switch

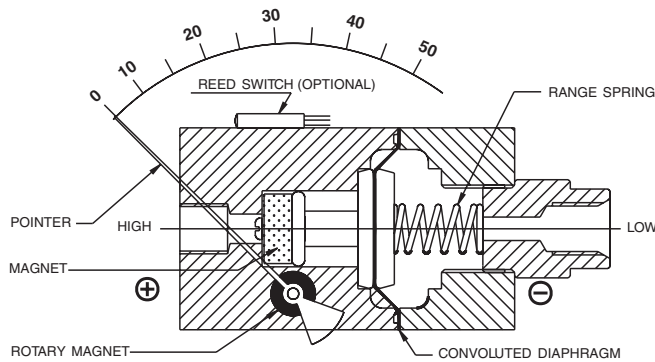

**Model 1132
Small Convuluted Diaphragm**

For efficient working of your gauge, please read all instructions carefully before attempting to install.

CAUTION: Do not exceed maximum operating pressure given on the gauge label. Check fluid compatibility with wetted parts before use.

OPERATING PRINCIPLE

High and Low pressures are separated by a sensor assembly consisting of a magnet, diaphragm and a range spring. The difference in pressure causes the sensor assembly to move in proportion to the change against a range spring.

A rotary magnet, located in a separate body compartment and isolated from the acting pressures is rotated by a magnetic coupling following the linear movement of the sensor assembly. A pointer attached to the rotary magnet indicates differential pressure on the dial.

SWITCH: Reed switches (optional) are located adjacent to the pressure chamber and are activated by the magnetic field of the sensor assembly.

Note: The gauges are calibrated to give $\pm 2\%$ full scale accuracy on ascending readings.

INSTALLATION

For better performance the gauge should be mounted horizontally with the dial vertical. Depressurize the system and connect the high and low pressure lines of your system to the "High" and "Low" ports of the gauge, respectively.

It is recommended to use "O" rings with male connectors to avoid excessive tightening and to prevent leakage (for parallel threads). The gauge is now ready for operation. Apply "High" and "Low" pressures simultaneously, to avoid damage to the internal parts.

Model 1132 consists of a small convoluted diaphragm to sense the pressure difference. It can withstand maximum operating pressure up to 1500 psi for all ranges. If pressure exceeds the rated maximum pressure, "O" rings and diaphragm inside the pressure chamber, will be damaged. If maximum operating pressure is within the allowable limit of 1500 psi, but the differential pressure exceeds gauge range, there will be no damage to the gauge. The pointer will only go to the extreme right end of the scale.

PRECAUTIONS

Do not connect "High" and "Low" ports to the wrong pipe ends. Do not subject the gauge to excessive vibration. The gauge is never to be used in an area where a magnetic field is present. It may show the wrong readings.

As the gauge works on a magnetic coupling principle, use only non-magnetic fittings, parts, etc. in areas closer than 2" on all sides, otherwise calibration will be affected. Panel mounted gauges should be installed in non-ferrous panel material. However, gauges with 2" and 2.5" dials, mounted in steel panels, may require pointer adjustment. This is done by the manufacturer, upon request.

Do not try to open any part of the gauge for any reason, because if not reassembled properly calibration will be affected.

SWITCH SETTING

Please follow these instructions when your differential pressure gauges are supplied with a switch. The switches are normally factory set to save the customer time. However, they are field adjustable.

CAUTION: Supply voltage should not exceed switch rating. For higher supply, use of relay circuit is recommended.

SWITCH ADJUSTMENT

The following procedure must be done by putting the gauge on test bench or while in actual service. The switch adjustment screw is located on the plastic cover. Rotate the screw counter clockwise to increase the setpoint and clockwise to decrease the setpoint. One or two trials may be necessary to attain the exact setpoint.

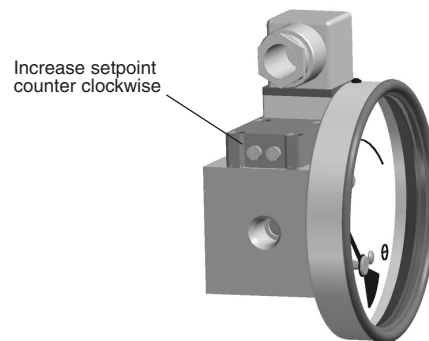

View from high pressure side

**Installation Instructions for
ASHCROFT® Model 1132
Differential Pressure Gauge/Switch**



SPST SWITCH

Specifications

Contact Rating : 10 VA ac (rms) or dc (max)
Switching Current : 0.5 Amp ac (rms) or dc (max)
Switch Voltage : 100 Vac/Vdc (max)

SPDT SWITCH

Specifications

Contact Rating : 3 VA ac (rms) or dc (max)
Switching Current : 0.3 Amp ac (rms) or dc (max)
Switch Voltage : 30 Vac/Vdc (max)

ONE SPST SWITCH

Reed Switches and Terminal Strip Connection

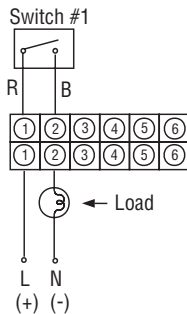

TWO SPST SWITCHES

Reed Switches and Terminal Strip Connection

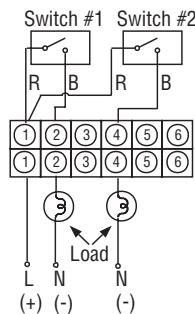

ONE SPDT SWITCH

Reed Switches and Terminal Strip Connection

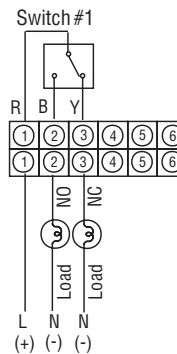

TWO SPDT SWITCHES

Reed Switches and Terminal Strip Connection

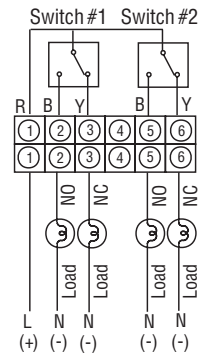

Reed Switches and DIN Plug Connection

View of socket for supply connections

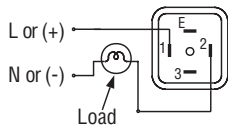

Reed Switches and DIN Plug Connection

View of socket for supply connections

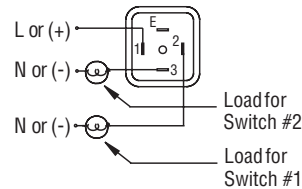

Reed Switches and DIN Plug Connection

View of socket for supply connections

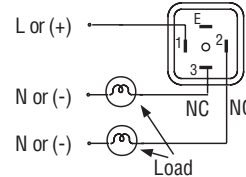

View of plug after removing the socket

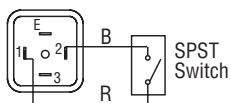

View of plug after removing the socket

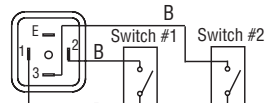

View of plug after removing the socket

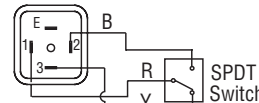

R = Red; B = Black; Y = Yellow; L = Live or + Supply; N = Neutral or - Supply.

*Body to be suitably grounded while using gauge + switch and only switch.