

This drawing includes confidential information which is the property of ASHCROFT INC. This copy is loaned for a specific purpose, with the understanding that it will not be reproduced or used for any other purpose or disclosed to others, and it will be returned on demand.

ASHCROFT INC.

250 EAST MAIN STREET
STRATFORD, CT 06614

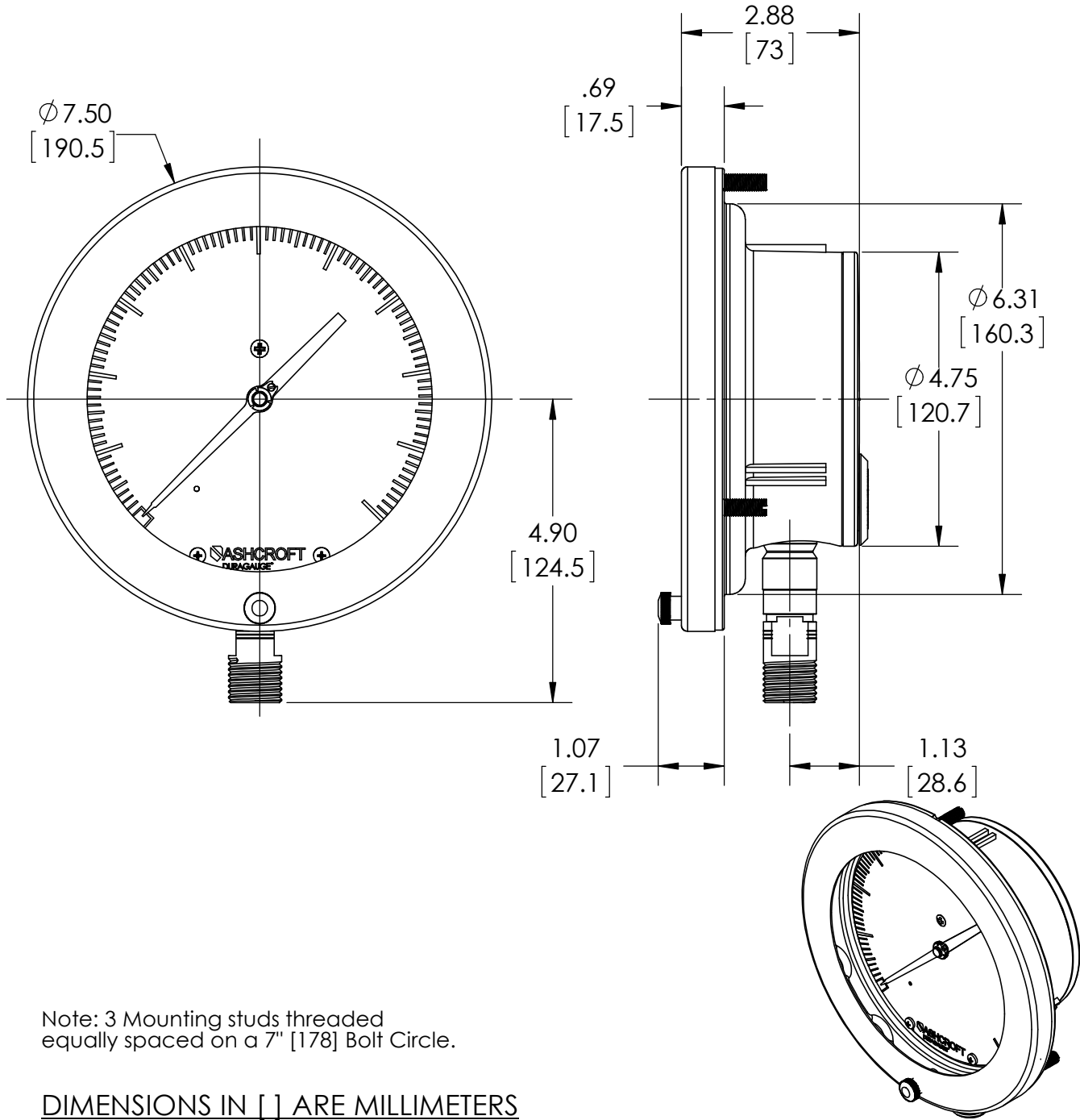

Note: 3 Mounting studs threaded equally spaced on a 7" [178] Bolt Circle.

DIMENSIONS IN [] ARE MILLIMETERS

REV.	ECO	DESCRIPTION	BY	DATE
A	0004455	RELEASED GENERAL DIMS. FOR 60 1377 04L	MJS	5/26/2010
B	0005457	Validation of Dimensions	MJS	2/17/2012

This print certified correct for		General Dimensions			
Customer's Name		60 1377 04L SERIES			
		HINGED RING DURAGAUGE			
Customer's Order No.	Drawn MJS	Date 5/26/10	Date of Issue		
Ashcroft Order No.	Checked	Date	SHEET-1		Rev.
Certified by	Date	Approved	Date	70A3021	B