

E2S Intrinsically Safe Pressure Transducer

FEATURES

- FM, ATEX, IECEx Intrinsically-Safe approvals, FM Non-Incendive approval
- Ranges vac through 1400 bar
- IP66/67 Ingress rating
- Wide selection of electrical & process connections available
- Customizable configurations
- External magnetic offset & span adjustment
- Barometric pressure ranges available (standard & custom ranges)

TYPICAL USES

- Oil field equipment
- Upstream oil & gas production
- Natural gas compression
- Alternative energy projects
- Engine monitoring
- Process & pneumatic sensing
- Hydrogen applications



E2S
Pressure Transducer

TruAccuracy



PERFORMANCE SPECIFICATIONS

Reference Temperature: 21 °C ±2 °C

Static Accuracy: ±0.25 % of span, ±0.50 % of span, ±1.0 % of span (0...100 mbar range only available in ±0.50 % and ±1.0 % accuracy) Terminal Point Method includes: hysteresis, linearity, repeatability, offset and span

Stability: ≤±0.25 % of span/year at reference conditions

ENVIRONMENTAL SPECIFICATIONS

Thermal Coefficients: Offset: ±0,09 % / 10 K (-40 to 125 °C)
Span: ±0,09 % / 10 K (-40 to 125 °C)

Temperature Limits: Storage: -50 °C to 125 °C
Operating: -40 °C to 80 °C
Media: -40 °C to 80 °C

Humidity: 0-100 % R.H. (non-condensing)

FUNCTIONAL SPECIFICATIONS

Response Time (Output): 4 ms

Gauge/Compound Pressure Ranges: -1 to 1400 bar (see Table 6 at page 7)
Vacuum to 20,000 psi

Shock: 80 g, 6 ms, Haversine

Vibration: Random: 10 g RMS 20-2000 Hz

Absolute Pressure Ranges: 0 to 1 up to 0 to 35 bar absolute
0 to 500 psia

Pressure: Proof: 1,2x to 2x
Burst: 3x to 8x
(see Table 1 at page 2)

KEY BENEFITS

- Highly configurable
- Easy calibration of offset and span

ELECTRICAL SPECIFICATIONS

Circuit Protection: Reverse polarity protected

Output Signal:	Supply Voltage: (unregulated)	
	Min.	Max
0-5 Vdc (3 Wire)	9 Vdc	36 Vdc
1-5 Vdc (3 Wire)	9 Vdc	36 Vdc
1-6 Vdc (3 Wire)	9 Vdc	36 Vdc
0-10 Vdc (3 Wire)	14 Vdc	36 Vdc
1-11 Vdc (3 Wire)	14 Vdc	36 Vdc
0,1-5 Vdc (3 Wire)	9 Vdc	36 Vdc
0,1-10 Vdc (3 Wire)	14 Vdc	36 Vdc
0,5-4,5 Vdc (3 Wire)	9 Vdc	36 Vdc
4-20 mA (2 Wire)	9 Vdc	36 Vdc
20-4 mA (2 Wire)	9 Vdc	36 Vdc

Adjustability: ±5% of span non-interactive offset & span

Supply Current: <8 mA (Vout)

Current Source/Sink for Voltage Output: 1 mA (source)/ 0,1 mA (sink) MAX.

Withstand/Breakdown: 100 Vdc/Vac, optional 500 Vdc/Vac

E2S Intrinsically Safe Pressure Transducer

PHYSICAL SPECIFICATIONS

Ingress Rating: IP66 (NEMA 4X) (STD.)
IP67 (IP69K Consult Factory)

WETTED MATERIAL

Diaphragm: Sensor: Material:
 A 17-4PH Stainless steel
 B 316L Stainless steel (1.4404)
 C 316L Stainless steel, liquid isolated (1.4404)
 D A286

Process Connection: Stainless steel 316L (1.4404)

NON-WETTED MATERIAL

Housing: Stainless steel 316L (1.4404)

APPROVALS

EMC: EU Directive 2014/30/EU
CE Industrial EN 61326-1, EN 61326-2-3

Immunity: EN 61000-4-2 ±4 kV/±8 kV (contact/air) (ESD)
 EN 61000-4-3 10 V/m to 1 GHz, 3 V/m to 2 GHz, 1 V/m to 2.7 GHz (Radiated RF)
 EN 61000-4-4 ±1 kV (5/50 ns, 5 kHz) (EFT/Burst)
 EN 61000-4-5 ±1 kV, Earth to Shield over all I/O lines (Surge)
 EN 61000-4-6 3 V/ (0.15 to 80 MHz) (Conducted RF)
 EN 61000-4-8 30 A/m (Line Freq. Magnetic)

RoHS: 2011/65/EU

Emissions: EN55011 (CISPR 11) Class A, Group 1
FCC (47 CFR 15)

HAZARDOUS AREA CERTIFICATIONS

Intrinsically Safe Installations

FM:
Class I, Division 1, Group A, B, C, D T4 -40 °C < Ta < 80 °C

ATEX/IECEx:
Class I, Zone 0, AEx ia IIC T4 Ga -40 °C < Ta < 80 °C
Class I, Zone 2, AEx ic IIC T4 Gc -40 °C < Ta < 80 °C

II 1 G Ex ia IIC T4 Ga -40 °C < Ta < 80 °C
II 3 G Ex ic IIC T4 Gc -40 °C < Ta < 80 °C

Non-Incendive Installations

FM:
Class I, Division 2, Group A, B, C, D T4 -40 °C < Ta < 80 °C

TABLE 1: PROOF & BURST PRESSURE MULTIPLIERS

Sensor Range	A Sensor - 17-4PH		B Sensor - 316 L		Sensor C - 316L ISO		Sensor D - A286	
	Proof	Burst	Proof	Burst	Proof	Burst	Proof	Burst
(psi)								
1.5					2x	5x		
5					3x	5x		
10					2x	5x		
15					2x	5x		
30					2x	5x		
45	2x	8x	1.5x	8x	2x	5x		
50	2x	8x	1.5x	8x	2x	5x		
60	2x	8x	1.5x	8x	2x	5x		
75	2x	8x	1.5x	8x	2x	5x		
100	2x	8x	1.5x	8x	2x	5x		
150	2x	8x	1.5x	8x	2x	4x		
200	2x	8x	1.5x	8x	2x	3x		
300	2x	8x	1.5x	8x	2x	3x		
500	2x	8x	1.2x	5x	3x	4x		
750	2x	8x	1.2x	5x				
1000	2x	8x	1.2x	5x				
1500	2x	8x	1.2x	5x				
2000	2x	8x	1.2x	5x				
3000	2x	5x	1.2x	5x				
5000	1.5x	5x	1.2x	5x			1.5x	5x
7500	1.5x	3x					1.5x	5x
10000	1.2x	3x					1.2x	5x
15000	1.2x	3x					1.2x	5x
20000	1.2x	3x					1.2x	5x
(Compound)								
VAC#					2x	5x		
V&15#					2x	5x		
V&30#					2x	5x		
V&45#	2x	8x	1.5x	8x				
V&60#	2x	8x	1.5x	8x	2x	5x		
V&100#	2x	8x	1.5x	8x				
V&150#	2x	8x	1.5x	8x	2x	4x		
V&200#	2x	8x	1.5x	8x				
V&300#	2x	8x	1.5x	8x	2x	3x		
(psia)								
15					2x	5x		
30					2x	5x		
70					2x	5x		
150					2x	4x		
300					2x	3x		
500					2x	3x		



E2S Intrinsically Safe Pressure Transducer

ORDERING CODE		EXAMPLE:	E2S	B	3	C	MG4	42	DA	M	10	M	100BR	XNH
Model														
E2S	E2S Pressure Transducer; Intrinsically Safe		E2S											
Sensor Materials - See Table 3 on page 4 for compatible ranges														
A	17-4PH Stainless steel			B										
B	316L Stainless steel (1.4404)													
C	316L Stainless steel (1.4404); liquid isolated													
D	A286													
Accuracy														
3	0,25 % of span (not available for pressure range 0 ... 100 mbar)				3									
5	0,50 % of span													
7	1,00 % of span													
X	According customer specification													
Calibration Chart														
N	Without calibration certificate													
C	Traceable calibration certificate					C								
Pressure Connections - See Table 3 on page 5 for more connection styles														
MG4	G 1/2 B Male (EN837-1)						MG4							
Output Type														
05	0-5 Vdc													
10	0-10 Vdc													
11	1-11 Vdc													
12	1-10 Vdc													
13	0.1-5 Vdc													
15	1-5 Vdc													
16	1-6 Vdc													
42	4-20 mA							42						
45	0.5-4.5 Vdc non-ratiometric													
00	Custom													
Electrical Connections - See Table 4 on page 6 for more options														
DA	Hirschmann angle connector acc. EN175301-803 Form A								DA					
Mating Connector														
M	With mating connector									M				
X	Without mating connector													
Cable Length														
Max cable length of 9 m (30ft) for outputs 05, 10, 11, 12, 13, 15, 16 and 45. Max cable length of 30 m (99ft) for outputs 24 and 42														
00	No cable													
XX	01 to 99										10			
Unit of Length														
F	Feet											M		
M	Meter													
N	Inches													
0	No cables													
Pressure Ranges - Coding example only, see Table 5 on page 7 for more options														
100BR	100 bar												100BR	
Options (If choosing an option(s) must include a "X")														
Cleaning														
6B	Cleaned for oxygen application													
6W	Cleaned for oxidizing processes other than Oxygen													
Marking/Tagging														
NH	Stainless steel tag wired (Information is required by the customer)													XNH
NN	Paper tag (Information is required by the customer)													
Others														
TU	Throttle plug													
Testing/Certificates														
CD2	Certificate according to EN 10204 2.2													



E2S Intrinsically Safe Pressure Transducer

ACCESSORY

Offset and Span Adjustment Magnet

266A143-01

Accessories must be ordered separately

TABLE 2 - SENSOR PRESSURE RANGE

psi	Sensor Material				bar	Sensor Material				inHg	Sensor Material			
	A 17-PH	B 316L	C 316 ISO	D A286		A 17-PH	B 316L	C 316 ISO	D A286		A 17-PH	B 316L	C 316 ISO	D A286
1.5#			•		100MB			•		3IM			•	
5#			•		400MB			•		10IM			•	
10#			•		600MB			•		20IM			•	
15#			•		1BR			•		30IM			•	
30#	•		•		1.6BR			•		50IM			•	
45#	•	•	•		2BR			•		100IM	•	•	•	
50#	•	•	•		2.5BR	•	•	•		200IM	•	•	•	
60#	•	•	•		4BR	•	•	•		300IM	•	•	•	
75#	•	•	•		6BR	•	•	•		500IM	•	•	•	
100#	•	•	•		10BR	•	•	•		1000IM	•	•		
150#	•	•	•		16BR	•	•	•		VACIM			•	
200#	•	•	•		20BR	•	•	•		V&30IM			•	
250#	•	•	•		25BR	•	•	•		V&60IM			•	
300#	•	•	•		40BR	•	•			V&100IM	•	•	•	
500#	•	•	•		60BR	•	•			V&200IM	•	•	•	
750#	•	•			100BR	•	•			30IMA			•	
1000#	•	•			160BR	•	•			50IMA			•	
1500#	•	•			200BR	•	•			100IMA			•	
2000#	•	•			250BR	•			•	200IMA			•	
2500#	•	•			400BR	•			•	300IMA			•	
3000#	•	•			600BR	•			•	500IMA			•	
5000#	•	•		•	1000BR	•			•	1000IMA			•	
7500#	•			•	1400BR	•			•					
10000#	•			•	VACBR			•						
15000#	•			•	V&1BR			•						
20000#	•			•	V&1.6BR			•						
VAC#			•		V&2BR			•						
V&15#			•		V&4BR	•	•	•						
V&30#			•		V&6BR	•	•	•						
V&45#	•	•	•		1BRA			•						
V&60#	•	•	•		1.6BRA			•						
V&100#	•	•	•		2BRA			•						
V&150#	•	•	•		2.5BRA			•						
V&200#	•	•	•		4BRA			•						
V&300#	•	•	•		6BRA			•						
15#A			•		10BRA			•						
30#A			•		16BRA			•						
50#A			•		20BRA			•						
100#A			•											
120#A			•											
300#A			•											

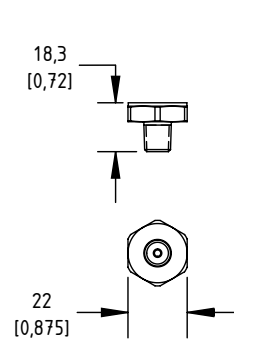
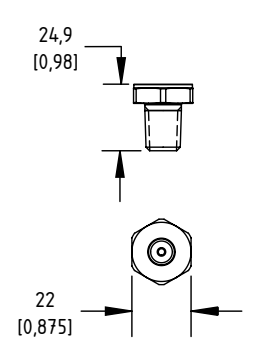
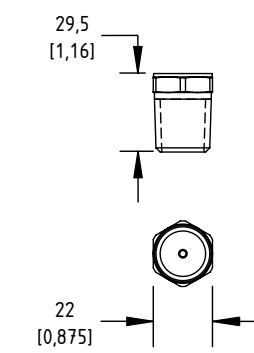
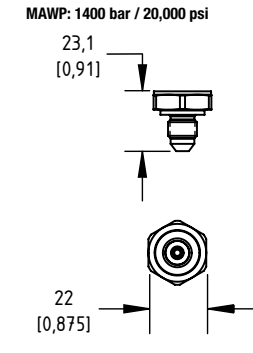
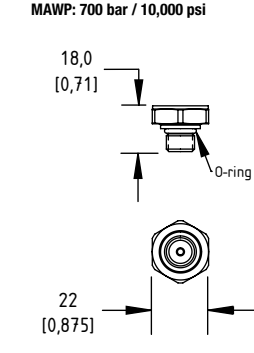
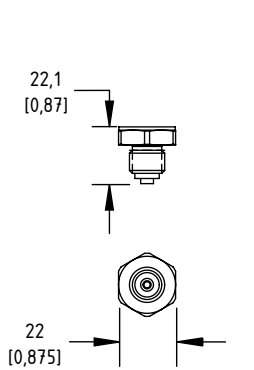
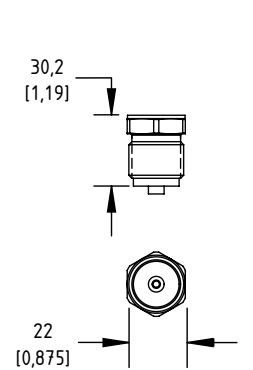
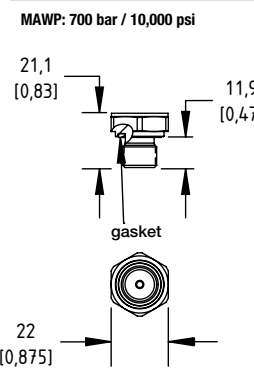
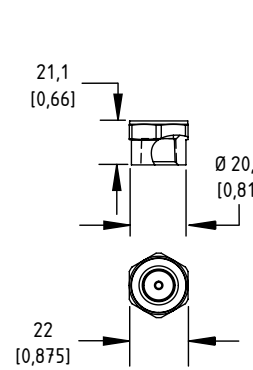
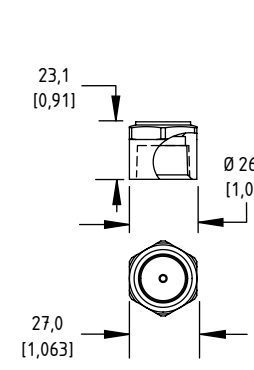
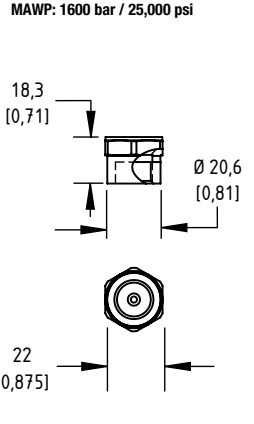
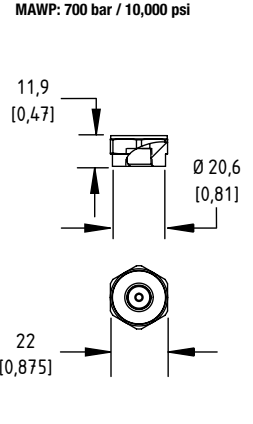
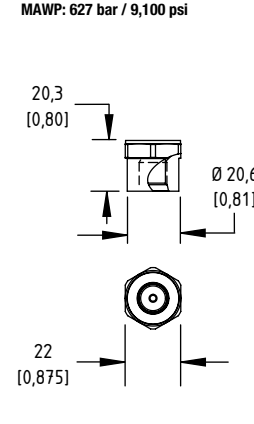
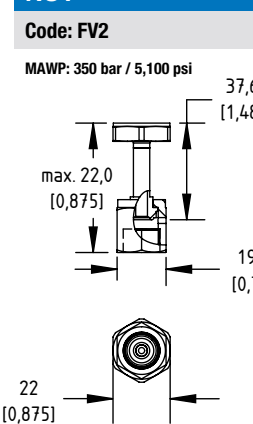
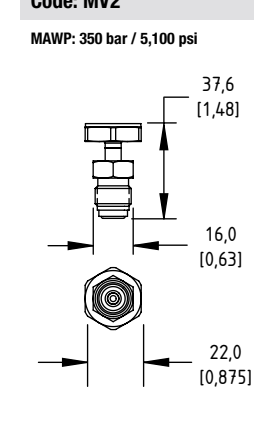

E2S Intrinsically Safe Pressure Transducer
TABLE 3 - PRESSURE CONNECTION DIMENSIONS IN MM [INCH]

1/8 NPT MALE Code: M01 MAWP: 1400 bar / 20,000 psi	1/4 NPT MALE Code: M02 MAWP: 1400 bar / 20,000 psi	1/2 NPT MALE Code: M04 MAWP: 700 bar / 10,000 psi	7/16-20 UNJF-3A 37° FLARE (SAE AS4395) Code: M76 MAWP: 1400 bar / 20,000 psi	7/16-20 UNJF-2A SAE-MALE (SAE J1926 O-RING BOSS SEAL) Code: MEK MAWP: 700 bar / 10,000 psi
				
G 1/4 B-MALE (EN837-1) Code: MG2 MAWP: 1400 bar / 20,000 psi	G 1/2 B MALE (EN837-1) Code: MG4 MAWP: 1400 bar / 20,000 psi	G 1/4 A-MALE (STUD END DIN 3852-E) Code: MGA MAWP: 700 bar / 10,000 psi	1/4-18 NPT FEMALE Code: F02 MAWP: 700 bar / 10,000 psi	1/2-14 NPT FEMALE Code: F04 MAWP: 345 bar / 5,000 psi
				
9/16-18 UNF-2B FEMALE Code: F09 MAWP: 1600 bar / 25,000 psi	1/8 -27 NPT FEMALE Code: F01 MAWP: 700 bar / 10,000 psi	7/16-20 UNF-2B SAEJ1926 Code: FRW MAWP: 627 bar / 9,100 psi	1/4" VCR GLAND WITH 9/16-18 FEMALE SWIVEL NUT Code: FV2 MAWP: 350 bar / 5,100 psi	1/4" VCR GLAND WITH 9/16-18 MALE SWIVEL NUT Code: MV2 MAWP: 350 bar / 5,100 psi
				



E2S Intrinsically Safe Pressure Transducer

TABLE 4 - ELECTRICAL CONNECTION DIMENSIONS IN MM [INCH]

Maximum temperature range listed

METRI PACK 3-PIN

Code: GN – IP67 (NEMA 4X)

-40 °C to 85 °C

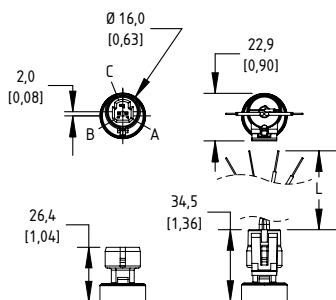

AMP SUPERSEAL 3-PIN

Code: AP – IP66 (NEMA 4X)

-40 °C to 85 °C

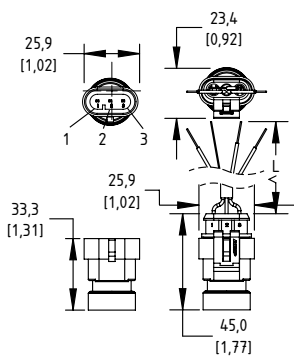

OVER-MOLD CABLE

Code: FC, FV – IP67 (NEMA 4X)

-40 °C to 85 °C

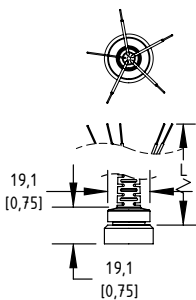

M12 4-PIN

Code: EW, RW – IP66 (NEMA 4X)

-40 °C to 85 °C

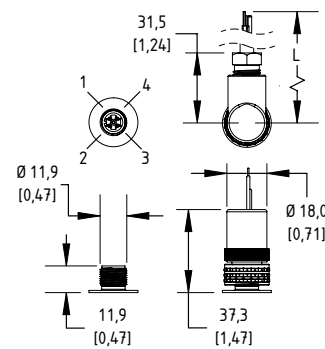

DEUTSCH DT04 3-PIN

Code: DT – IP66 (NEMA 4X)

-40 °C to 85 °C

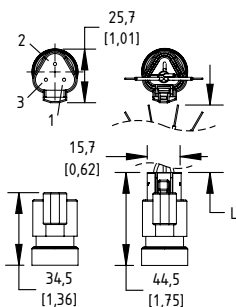

HIRSCHMAN EN 175301-803 FORM A

Code: DA – IP66 (NEMA 4X)

-40 °C to 85 °C

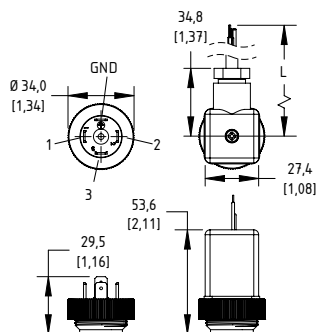

MINI-HIRSCHMAN

Code: HM – IP66 (NEMA 4X)

-40 °C to 85 °C

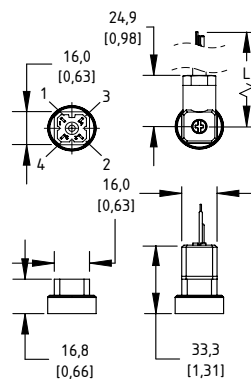

MIL DTL 26482 8 4-PIN

Code: B4 – No IP or NEMA rating

-25 °C to 105 °C

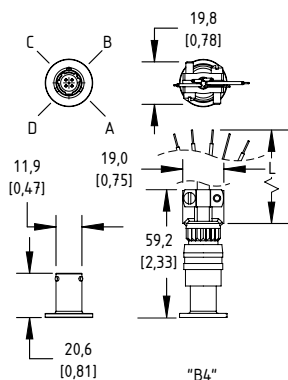

HIRSCHMAN EN 175301-803 FORM C

Code: DC
IP66 (NEMA 4X)

-40 °C to 85 °C

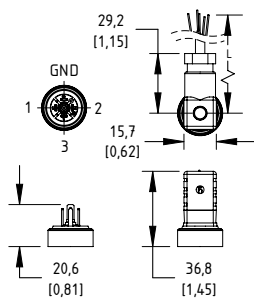

M20 CONDUIT WITH CABLE

Code: MC, MV⁽¹⁾ –
IP67 (NEMA 4X)

-40 °C to 125 °C

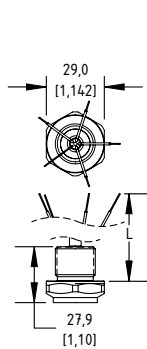

1/2" NPT CONDUIT WITH CABLE

Code: CC, CV⁽¹⁾ –
IP67 (NEMA 4X)

-40 °C to 125 °C

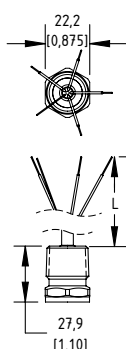

1/2" NPT CONDUIT WITH FLYING LEADS

Code: CF
IP67 (NEMA 4X)

-40 °C to 125 °C

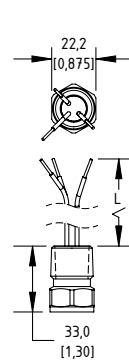

M20 CONDUIT WITH FLYING LEADS

Code: MF
IP67 (NEMA 4X)

-40 °C to 125 °C

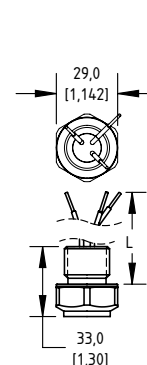

(1) indicates vented cable



E2S Intrinsically Safe Pressure Transducer
TABLE 5 - PRESSURE RANGES

	PSI	bar	inHg
Vac.	VAC#	VACBR	VACIM
	V&15#	V&1BR	V&30IM
	—	V&1.6BR	—
	V&30#	V&2BR	V&60IM
	V&45#	—	V&100IM
	V&60#	V&4BR	—
	—	V&6BR	—
	V&100#	—	V&200IM
	V&150#	—	—
	V&200#	—	—
V&300#	—	—	
Compound	1.5#	100MB	3IM
	5#	400MB	10IM
	—	600MB	—
	10#	—	20IM
	15#i	1BR	30IM
	—	1.6BR	50IM
	30#	2BR	—
	—	2.5BR	—
	45#	—	—
	50#	—	100IM
	60#	4BR	—
	75#	—	—
	—	6BR	—
	100#	—	200IM
	150#	10BR	300IM
	200#	—	—
	—	16BR	—
	250#	—	500IM
	300#	20BR	—
	—	25BR	—
	500#	—	1000IM
	—	40BR	—
	750#	—	—
	—	60BR	—
	1000#	—	—
	1500#	100BR	—
	2000#	160BR	—
	—	200BR	—
	2500#	—	—
	3000#	—	—
—	250BR	—	
5000#	—	—	
—	400BR	—	
7500#	—	—	
—	600BR	—	
1000#	—	—	
15000#	1000BR	—	
20000#	—	—	
Positive Pressure (psig)	15#A	1BRA	30IMA
	—	1.6BRA	50IMA
	30#A	2BRA	—
	—	2.5BRA	—
	50#A	—	100IMA
	—	4BRA	—
	—	6BRA	—
	100#A	—	200IMA
	—	10BRA	300IMA
	200#A	—	—
—	16BRA	500IMA	
—	20BRA	—	
500#A	—	—	
Absolute Pressure (psia)	15#A	1BRA	30IMA
	—	1.6BRA	50IMA
	30#A	2BRA	—
	—	2.5BRA	—
	50#A	—	100IMA
	—	4BRA	—
	—	6BRA	—
	100#A	—	200IMA
	—	10BRA	300IMA
	200#A	—	—
—	16BRA	500IMA	
—	20BRA	—	
500#A	—	—	

DIMENSIONS IN MM [INCH]

For reference only, consult Ashcroft for specific dimensional drawings

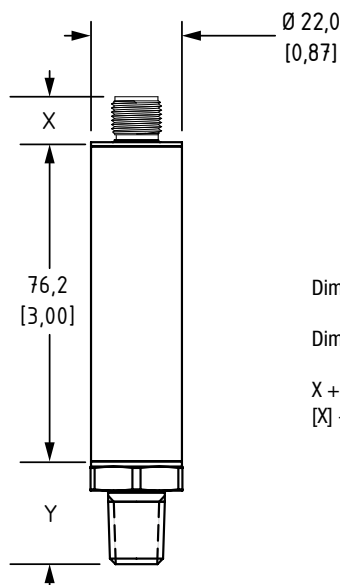

Dimensions for X can be found on page 6

Dimensions for Y can be found on page 5

 $X + Y + 76.2 \text{ mm} = \text{total length in mm}$
 $[X] + [Y] + 3.00" = \text{total length in inches}$

E2S Intrinsically Safe Pressure Transducer

PIN ASSIGNMENT

All other pin assignments are shown in the instruction manual

CODE EW AND RW

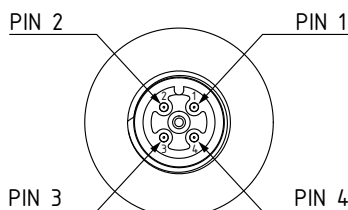

	PIN 1	PIN 2	PIN 3	PIN 4
EW CURRENT	V+	Case ground	V-	V-
EW VOLTAGE	V+	Case ground	Common	Output
RW CURRENT	V+	V-	Case ground	V-
RW VOLTAGE	V+	Output	Case ground	Common

LOAD LIMITATIONS 4-20 MA OUTPUT ONLY

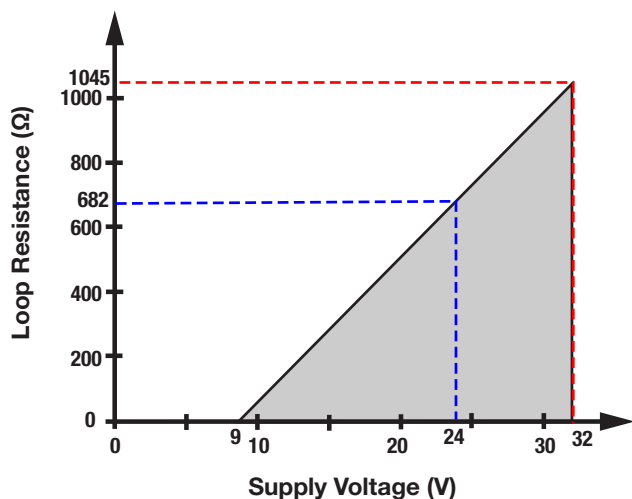

- Maximum allowed loop resistance for a 32 VDC supply network
- Example (loop resistance of 682 Ω required a minimum supply voltage of 24 VDC)

$$V_{\text{MIN}} = 9 \text{ V} + [0.022 \text{ A} \times (R_L)]$$

(*includes a 10% safety factor)

$$R_L = R_s + R_w$$

R_L = Loop Resistance (Ω)
 R_s = Sense Resistance (Ω)

Note: See power supply requirement chart for maximum supply voltage limits

TruAccuracy

What Does It Mean?

Ashcroft's TruAccuracy™ specification is exclusively based on terminal point methodology instead of statistically derived schemes like 'best fit straight line'.

TruAccuracy™ means the Ashcroft E2S has ±0.25% of span accuracy out of the box. Zero and span setting errors are already included in the ±0.25% of span accuracy spec.

The E2S is ready to be installed with no additional calibration adjustments required.

A unit from another manufacturer advertised as ±0.25% best fit straight line may actually be a ±1.25% to ±2.25% device. Using best fit straight line method, the accuracy spec does not include zero and span setting errors, which can be as much as ±1.00% each.