

E2G Pressure Transducer

FEATURES

- Ranges from 100 mbar through 1400 bar (20,000 psi)
- IP66/67 Ingress rating
- Wide selection of electrical and process connections
- Customizable configurations
- External magnetic offset and span adjustment
- Barometric pressure ranges available (standard and custom ranges)
- SIL 3 capable

TYPICAL USES

- Off-Road equipment
- Construction machinery
- HVAC/Refrigeration
- Compressor control
- Pump monitoring
- Agricultural equipment
- Diagnostic kits
- Engine monitoring
- Process automation and controls
- Hydraulic and pneumatic sensing

PERFORMANCE SPECIFICATIONS

Reference Temperature: 21 °C ±2 °C (70 °F ±2 °F)

Static Accuracy: ±0.25 % of span, ±0.50 % of span, ±1.0 % of span (0...100 mbar range only available in ±0.50 % and ±1.0 % accuracy) Terminal Point Method includes: hysteresis, linearity, repeatability, offset and span

Stability: ≤±0.25 % of span/year at reference conditions

ENVIRONMENTAL SPECIFICATIONS

Thermal Coefficients: Offset: ±0,09 % / 10 K (-40 bis 125 °C)
Span: ±0,09 % / 10 K (-40 bis 125 °C)

Temperature Limits: Storage: -50 °C to 125 °C
Operating: -40 °C to 125 °C
Media: -40 °C to 125 °C

Humidity: 0-100 % R.H. (non-condensing)

FUNCTIONAL SPECIFICATIONS

Response Time (Output): 4 ms

Gauge/Compound: -1 to 1400 bar
Pressure Ranges: Vacuum to 20,000 psi (see Table 6 at page 7)

Shock: 80 g, 6 ms, Haversine

Vibration: Random: 10 g RMS 20-2000 Hz

Absolute Pressure Ranges: 0 to 1 up to 0 to 35 bar absolute
0 to 500 psia

Pressure: Proof: 1,2x to 2x
Burst: 3x to 8x
(see Table 1 at page 2)



E2G
Pressure Transducer



KEY BENEFITS

- Highly configurable
- Easy calibration of offset and span
- SIL Certified

ELECTRICAL SPECIFICATIONS

Circuit Protection: Reverse polarity protected

Output Signal:	Supply Voltage: (unregulated)	
	Min.	Max
0-5 Vdc (3 Wire)	9 Vdc	36 Vdc
1-5 Vdc (3 Wire)	9 Vdc	36 Vdc
1-6 Vdc (3 Wire)	9 Vdc	36 Vdc
0-10 Vdc (3 Wire)	14 Vdc	36 Vdc
1-11 Vdc (3 Wire)	14 Vdc	36 Vdc
0,1-5 Vdc (3 Wire)	9 Vdc	36 Vdc
0,1-10 Vdc (3 Wire)	14 Vdc	36 Vdc
0,5-4,5 Vdc (3 Wire)	9 Vdc	36 Vdc
4-20 mA (2 Wire)	9 Vdc	36 Vdc
20-4 mA (2 Wire)	9 Vdc	36 Vdc

Adjustability: ±5% of span non-interactive offset & span

Supply Current: <8 mA (Vout)

Curent Source/Sink for Voltage Output: 1 mA (source)/ 0,1 mA (sink) MAX.

Withstand/Breakdown: 100 Vdc/Vac, optional 500 Vdc/Vac

E2G Pressure Transducer

PHYSICAL SPECIFICATIONS

Ingress Rating: IP66 (NEMA 4X) (STD.)
IP67 (IP69K Consult Factory)

WETTED MATERIAL

Diaphragm: Sensor: Material:
 A 17-4PH® Stainless steel
 B 316L Stainless steel (1.4404)
 C 316L Stainless steel, liquid isolated (1.4404)
 D A286
 **A" sensor with ranges of 10,000 psi and above include 316 Stainless steel and 17-4 PH® H900 Stainless steel (process connection).

Process Connection: Stainless steel 316L (1.4404)

NON-WETTED MATERIAL

Housing: Stainless steel 316L (1.4404)

APPROVALS

EMC: Directive 2014/30/EU, and EN61326-1, EN61326-2-3 (Industrial Env.)

Immunity: EN 61000-4-2 ±4 kV/±8 kV (air discharge) (ESD)
 EN 61000-4-3 10 V/m to 1 GHz, 3 V/m to 2 GHz, 1 V/m to 2.7 GHz (Radiated RF)
 EN 61000-4-4 ±1 kV (5/50 ns, 5 kHz) (EFT/Burst)
 EN 61000-4-5 ±1 kV, Earth to Shield over all I/O lines (Surge)
 EN 61000-4-6 3 V/ (0.15 to 80 MHz) (Conducted RF)
 EN 61000-4-8 30 A/m (Line Freq. Magnetic)

RoHS: 2011/65/EU

Emissions: EN55011 (CISPR 11) Class A, Group 1
FCC (47 CFR 15)

CE, UKCA,UL/ cUL Recognized component (UL 61010-1, CSA 22.2 61010-1), Electrical Equipment for Measurement, Control, and Laboratory Use.

TABLE 1: PROOF & BURST PRESSURE MULTIPLIERS

Sensor Range	A Sensor - 17-4PH® SS		B Sensor - 316 LSS		C Sensor - 316L SS ISO		D Sensor - A286	
	Proof	Burst	Proof	Burst	Proof	Burst	Proof	Burst
(psi)								
1.5					2x	5x		
5					3x	5x		
10					2x	5x		
15					2x	5x		
30					2x	5x		
45	2x	8x	1.5x	8x	2x	5x		
50	2x	8x	1.5x	8x	2x	5x		
60	2x	8x	1.5x	8x	2x	5x		
75	2x	8x	1.5x	8x	2x	5x		
100	2x	8x	1.5x	8x	2x	5x		
150	2x	8x	1.5x	8x	2x	4x		
200	2x	8x	1.5x	8x	2x	3x		
300	2x	8x	1.5x	8x	2x	3x		
500	2x	8x	1.2x	5x	3x	4x		
750	2x	8x	1.2x	5x				
1000	2x	8x	1.2x	5x				
1500	2x	8x	1.2x	5x				
2000	2x	8x	1.2x	5x				
3000	2x	5x	1.2x	5x				
5000	1.5x	5x	1.2x	5x			1.5x	5x
7500	1.5x	3x					1.5x	5x
10000	1.2x	3x					1.2x	5x
15000	1.2x	3x					1.2x	5x
20000	1.2x	3x					1.2x	5x
(Compound)								
VAC#					2x	5x		
V&15#					2x	5x		
V&30#					2x	5x		
V&45#	2x	8x	1.5x	8x				
V&60#	2x	8x	1.5x	8x	2x	5x		
V&100#	2x	8x	1.5x	8x				
V&150#	2x	8x	1.5x	8x	2x	4x		
V&200#	2x	8x	1.5x	8x				
V&300#	2x	8x	1.5x	8x	2x	3x		
(psia)								
15					2x	5x		
30					2x	5x		
70					2x	5x		
150					2x	4x		
300					2x	3x		
500					2x	3x		



E2G Pressure Transducer

ORDERING CODE	EXAMPLE:	E2G	B	3	C	MG4	42	DA	X	10	M	10BR	XNH
Model	E2G Pressure Transducer; General Purpose	E2G											
Sensor Materials - See Table 3 on page 4 for compatible ranges													
A	17-4PH® Stainless steel		B										
B	316L Stainless steel (1.4404)												
C	316L Stainless steel (1.4404); liquid isolated												
D	A286												
Accuracy													
3	0,25 % of span (not available for pressure range 0 ... 100 mbar)			3									
5	0,50 % of span												
7	1,00 % of span												
X	According customer specification												
Calibration Chart													
N	Without calibration chart												
C	With calibration chart				C								
Pressure Connections - See Table 3 on page 5 for more connection styles													
MG4	G 1/2 B Female (EN837-1)					MG4							
Output Type													
05	0-5 Vdc												
10	0-10 Vdc												
11	1-11 Vdc												
12	1-10 Vdc												
13	0.1-5 Vdc												
15	1-5 Vdc												
16	1-6 Vdc												
42	4-20 mA						42						
45	0.5-4.5 Vdc non-ratiometric												
00	Custom												
Electrical Connections - See Table 4 on page 6 for more options													
DA	Hirschmann angle connector acc. EN175301-803 Form A							DA					
Mating Connector													
M	With mating connector												
X	Without mating connector								X				
Cable Length													
Max cable length of 9 m (30ft) for outputs 05, 10, 11, 12, 13, 15, 16 and 45. Max cable length of 30 m (99ft) for outputs 24 and 42													
00	No cable												
XX	01 to 99									10			
Unit of Length													
F	Feet											M	
M	Meter												
N	Inches												
0	No cables												
Pressure Ranges - Coding example only, see Table 5 on page 7 for more options													
10BR	10 bar											10BR	
Options (If choosing an option(s) must include a "X")													
Cleaning													
6B	Cleaned for oxygen application (not available with liquid filled sensors)												
6W	Cleaned for oxidizing processes other than Oxygen												
Marking/Tagging													
NH	Stainless steel tag wired (Information is required by the customer)												XNH
NN	Paper tag (Information is required by the customer)												
Others													
TU	Throttle plug												
1L	SIL certification for E2 series transducer												
Testing/Certificates													
CD2	Certificate according to EN 10204 2.2												



E2G Pressure Transducer

ACCESSORY

Offset and Span Adjustment Magnet 266A143-01

Accessories must be ordered separately

TABLE 2 - SENSOR PRESSURE RANGE

psi	Sensor Material				bar	Sensor Material				inHg	Sensor Material			
	A 17-PH®	B 316L	C 316 ISO	D A286		A 17-PH®	B 316L	C 316 ISO	D A286		A 17-PH®	B 316L	C 316 ISO	D A286
1.5#			•					•						
5#			•		400MB			•		10IM		•		
10#			•		600MB			•		20IM		•		
15#			•		1BR			•		30IM		•		
30#	•	•	•		1.6BR			•		50IM		•		
45#	•	•	•		2BR			•		100IM	•	•	•	
50#	•	•	•		2.5BR	•	•	•		200IM	•	•	•	
60#	•	•	•		4BR	•	•	•		300IM	•	•	•	
75#	•	•	•		6BR	•	•	•		500IM	•	•	•	
100#	•	•	•		10BR	•	•	•		1000IM	•	•		
150#	•	•	•		16BR	•	•	•		VACIM		•		
200#	•	•	•		20BR	•	•	•		V&30IM		•		
250#	•	•	•		25BR	•	•	•		V&60IM		•		
300#	•	•	•		40BR	•	•			V&100IM	•	•	•	
500#	•	•	•		60BR	•	•			V&200IM	•	•	•	
750#	•	•			100BR	•	•			30IMA		•		
1000#	•	•			160BR	•	•			50IMA		•		
1500#	•	•			200BR	•	•			100IMA		•		
2000#	•	•			250BR	•			•	200IMA		•		
2500#	•	•			400BR	•			•	300IMA		•		
3000#	•	•			600BR	•			•	500IMA		•		
5000#	•	•		•	1000BR	•				1000IMA		•		
7500#	•			•	VACBR			•		700& 1100MBA		•		
10000#	•			•	V&1BR			•		900& 1100MBA		•		
15000#	•			•	V&1.6BR			•						
20000#	•			•	V&2BR			•						
VAC#			•		V&4BR	•	•	•						
V&15#	•		•		V&6BR	•	•	•						
V&30#	•		•		1BRA			•						
V&45#	•	•	•		1.6BRA			•						
V&60#	•	•	•		2BRA			•						
V&100#	•	•	•		2.5BRA			•						
V&150#	•	•	•		4BRA			•						
V&200#	•	•	•		6BRA			•						
V&300#	•	•	•		10BRA			•						
15#A			•		16BRA			•						
30#A			•		20BRA			•						
50#A			•											
100#A			•											
120#A			•											
300#A			•											



E2G Pressure Transducer

TABLE 3 - PRESSURE CONNECTION DIMENSIONS IN MM [INCH]

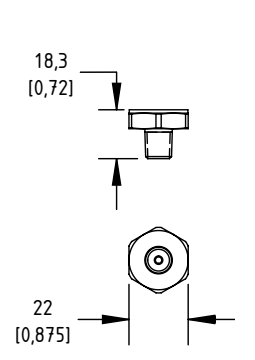
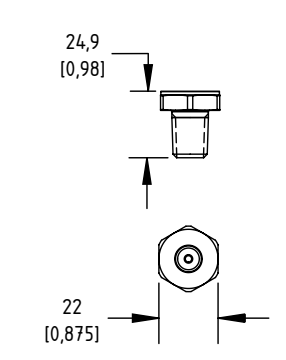
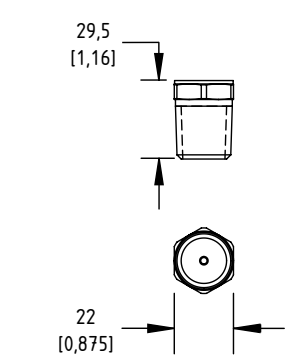
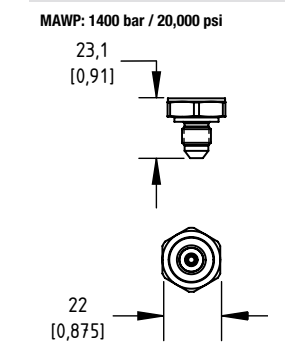
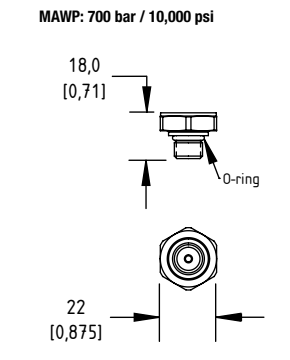
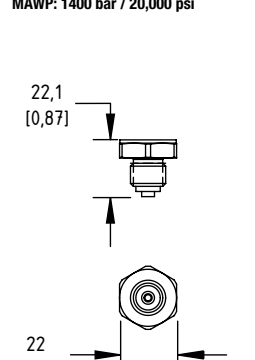
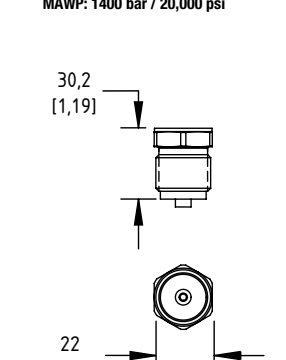
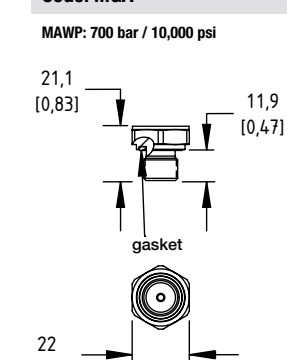
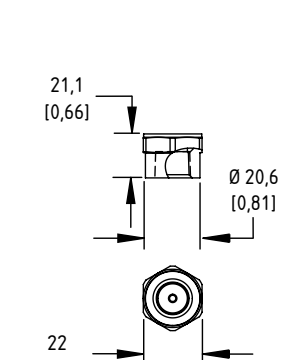
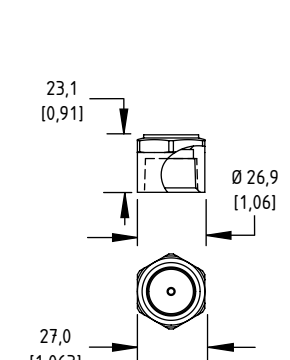
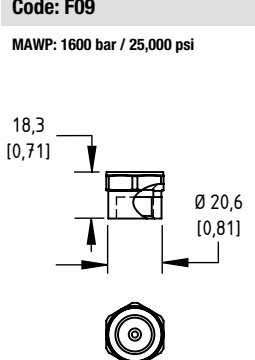
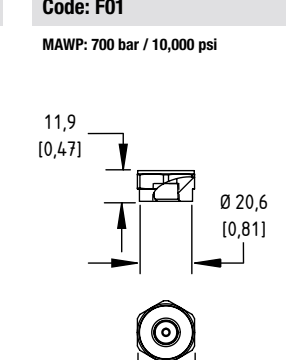
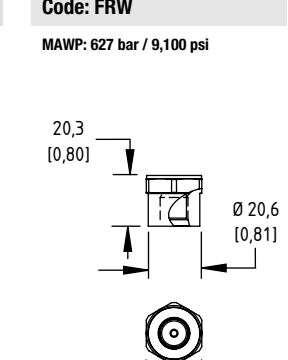
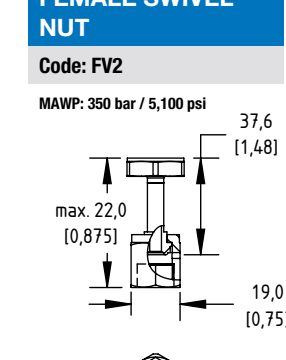
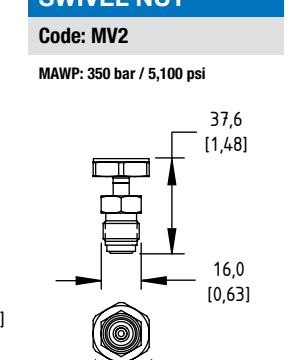
<p>1/8 NPT MALE Code: MO1 MAWP: 1400 bar / 20,000 psi</p> 	<p>1/4 NPT MALE Code: MO2 MAWP: 1400 bar / 20,000 psi</p> 	<p>1/2 NPT MALE Code: MO4 MAWP: 700 bar / 10,000 psi</p> 	<p>7/16-20 UNJF-3A 37° FLARE (SAE AS4395) Code: M76 MAWP: 1400 bar / 20,000 psi</p> 	<p>7/16-20 UNJF-2A SAE-MALE (SAE J1926 O-RING BOSS SEAL) Code: MEK MAWP: 700 bar / 10,000 psi</p> 
<p>G 1/4 B-MALE (EN837-1) Code: MG2 MAWP: 1400 bar / 20,000 psi</p> 	<p>G 1/2 B MALE (EN837-1) Code: MG4 MAWP: 1400 bar / 20,000 psi</p> 	<p>G 1/4 A-MALE (STUD END DIN 3852-E) Code: MGA MAWP: 700 bar / 10,000 psi</p> 	<p>1/4-18 NPT FEMALE Code: F02 MAWP: 700 bar / 10,000 psi</p> 	<p>1/2-14 NPT FEMALE Code: F04 MAWP: 345 bar / 5,000 psi</p> 
<p>9/16-18 UNF-2B FEMALE Code: F09 MAWP: 1600 bar / 25,000 psi</p> 	<p>1/8 -27 NPT FEMALE Code: F01 MAWP: 700 bar / 10,000 psi</p> 	<p>7/16-20 UNF-2B SAEJ1926 Code: FRW MAWP: 627 bar / 9,100 psi</p> 	<p>1/4" VCR GLAND WITH 9/16-18 FEMALE SWIVEL NUT Code: FV2 MAWP: 350 bar / 5,100 psi</p> 	<p>1/4" VCR GLAND WITH 9/16-18 MALE SWIVEL NUT Code: MV2 MAWP: 350 bar / 5,100 psi</p> 



E2G Pressure Transducer

TABLE 4 - ELECTRICAL CONNECTION DIMENSIONS IN MM [INCH]

Maximum temperature range listed

METRI PACK 3-PIN

Code: GN – IP67 (NEMA 4X)

-40 °C to 85 °C

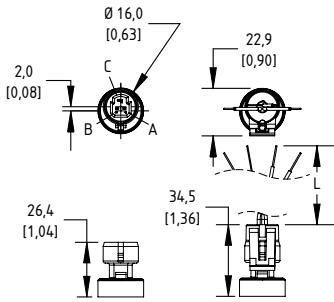

AMP SUPERSEAL 3-PIN

Code: AP – IP66 (NEMA 4X)

-40 °C to 85 °C

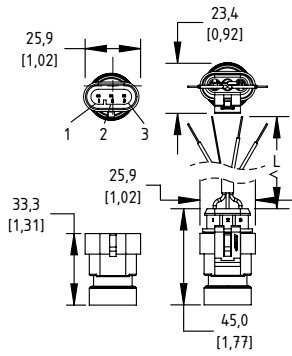

OVER-MOLD CABLE

Code: FC, FV – IP67 (NEMA 4X)

-40 °C to 85 °C

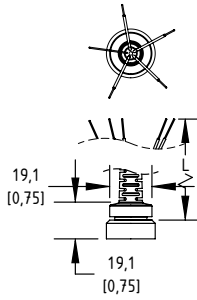

M12 4-PIN

Code: EW, RW – IP66 (NEMA 4X)

-40 °C to 85 °C

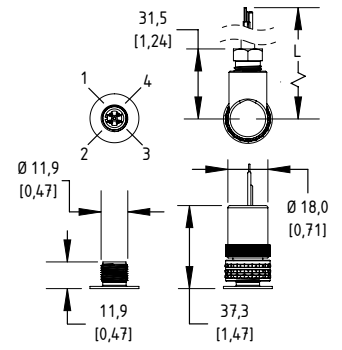

DEUTSCH DT04 3-PIN

Code: DT – IP66 (NEMA 4X)

-40 °C to 85 °C

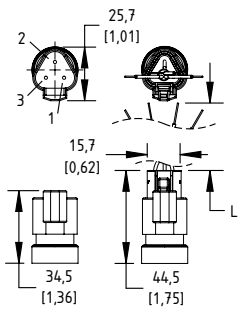

HIRSCHMAN EN 175301-803 FORM A

Code: DA – IP65 (NEMA 4X)

-40 °C to 85 °C

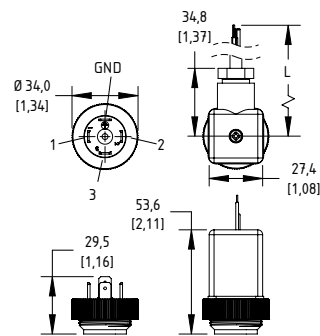

MINI-HIRSCHMAN

Code: HM – IP65 (NEMA 4X)

-40 °C to 85 °C

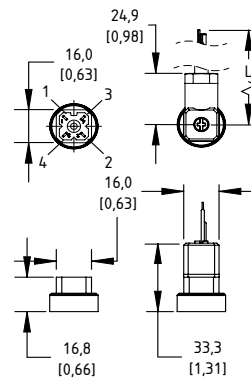

MIL DTL 26482 8 4-PIN

Code: B4 – No IP or NEMA rating

-25 °C to 105 °C

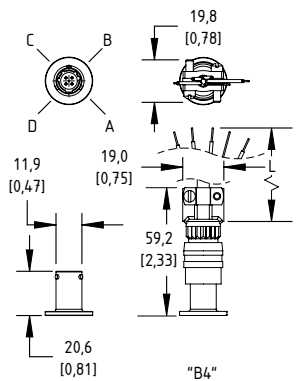

HIRSCHMAN EN 175301-803 FORM C

Code: DC
IP65 (NEMA 4X)

-40 °C to 85 °C

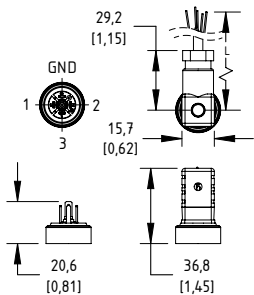

M20 CONDUIT WITH CABLE

Code: MC, MV⁽¹⁾ – IP67 (NEMA 4X)

-40 °C to 125 °C

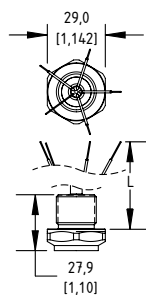

1/2" NPT CONDUIT WITH CABLE

Code: CC, CV⁽¹⁾ – IP67 (NEMA 4X)

-40 °C to 125 °C



1/2" NPT CONDUIT WITH FLYING LEADS

Code: CF
IP67 (NEMA 4X)

-40 °C to 125 °C

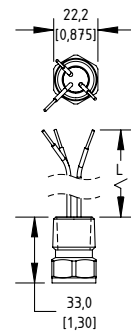

M20 CONDUIT WITH FLYING LEADS

Code: MF
IP67 (NEMA 4X)

-40 °C to 125 °C

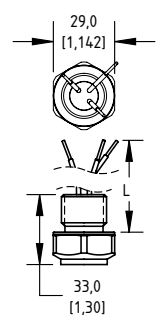

(1) indicates vented cable

Ashcroft Instruments GmbH

Deutschland / Germany
Max-Planck-Str. 1
D-52499 Baesweiler
Tel.: +49 (0) 2401 808-0

For more information on support and local partners please visit our web page at ashcroft.eu or follow the QR-Code



E2G Pressure Transducer

TABLE 5 - PRESSURE RANGES

Vac.	PSI	bar	inHg
	VAC#	VACBR	VACIM
Compound	V&15#	V&1BR	V&30IM
	—	V&1.6BR	—
	V&30#	V&2BR	V&60IM
	V&45#	—	V&100IM
	V&60#	V&4BR	—
	—	V&6BR	—
	V&100#	—	V&200IM
	V&150#	—	—
	V&200#	—	—
	V&300#	—	—
Positive Pressure (psig)	1.5#	100MB	3IM
	5#	400MB	10IM
	—	600MB	—
	10#	—	20IM
	15#i	1BR	30IM
	—	1.6BR	50IM
	30#	2BR	—
	—	2.5BR	—
	45#	—	—
	50#	—	100IM
	60#	4BR	—
	75#	—	—
	—	6BR	—
	100#	—	200IM
	150#	10BR	300IM
	200#	—	—
	—	16BR	—
	250#	—	500IM
	300#	20BR	—
	—	25BR	—
500#	—	1000IM	
—	40BR	—	
750#	—	—	
—	60BR	—	
1000#	—	—	
1500#	100BR	—	
2000#	160BR	—	
—	200BR	—	
2500#	—	—	
3000#	—	—	
—	250BR	—	
5000#	—	—	
—	400BR	—	
7500#	—	—	
—	600BR	—	
1000#	—	—	
15000#	1000BR	—	
20000#	—	—	
Absolute Pressure (psia)	15#A	1BRA	30IMA
	—	1.6BRA	50IMA
	30#A	2BRA	—
	—	2.5BRA	—
	50#A	—	100IMA
	—	4BRA	—
	—	6BRA	—
	100#A	—	200IMA
	—	10BRA	300IMA
	200#A	—	—
—	16BRA	500IMA	
—	20BRA	—	
500#A	—	—	

DIMENSIONS IN MM [INCH]

For reference only, consult Ashcroft for specific dimensional drawings

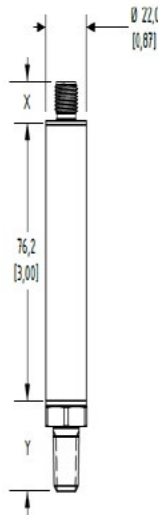

Dimensions for X can be found on page 6

Dimensions for Y can be found on page 5

$X + Y + 76.2 \text{ mm} = \text{total length in mm}$
 $[X] + [Y] + 3.00" = \text{total length in inches}$

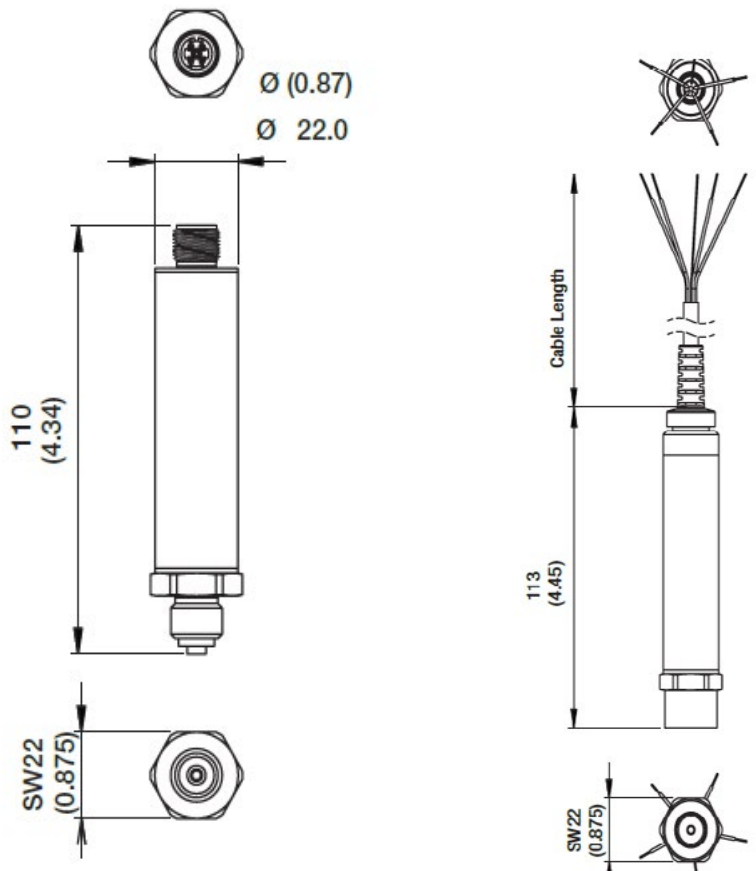

E2G Pressure Transducer

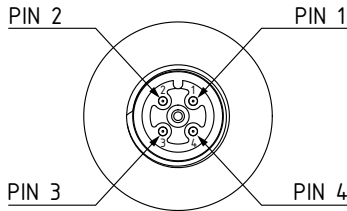

	PIN 1	PIN 2	PIN 3	PIN 4
EW CURRENT	V+	Case ground	V-	V-
EW VOLTAGE	V+	Case ground	Common	Output
RW CURRENT	V+	V-	Case ground	V-
RW VOLTAGE	V+	Output	Case ground	Common

ALL OTHER PIN ASSIGNMENTS ARE SHOWN IN THE INSTRUCTION MANUAL



What Does It Mean?

Ashcroft's TruAccuracy™ specification is exclusively based on terminal point methodology instead of statistically derived schemes like 'best fit straight line'.

TruAccuracy™ means the Ashcroft E2G has $\pm 0.25\%$ of span accuracy out of the box. Zero and span setting errors are already included in the $\pm 0.25\%$ of span accuracy spec.

The E2G is ready to be installed with no additional calibration adjustments required.

A unit from another manufacturer advertised as $\pm 0.25\%$ best fit straight line may actually be a $\pm 1.25\%$ to $\pm 2.25\%$ device. Using best fit straight line method, the accuracy spec does not include zero and span setting errors, which can be as much as $\pm 1.00\%$ each.

