

Operating Manual



Diaphragm Seals Models 5XX und DX (non-electrical device) in an #####=ATEX finish

For explosion risk areas in accordance with Directive 2014/34/EU (ATEX)
Zone 1 and 2, and Zone 21 and 22; risk from gases and dry dusts



Table of contents:

1	General remarks.....	3
1.1	Purpose of this Manual	3
1.2	Symbols	3
1.3	Limits of liability.....	3
1.4	Copyright.....	3
1.5	Warranty	3
1.6	Manufacturer's address, customer services	3
2	Safety.....	4
2.1	General sources of hazards.....	4
2.2	Use in accordance with intended purpose.....	4
2.3	Operator's responsibility	4
2.4	Staff qualifications (target group assessment)	4
2.5	Signs/Safety markings	4
2.6	Safety equipment	5
2.7	Environmental protection	5
3	Use in explosion risk areas in accordance with Directive 94/9/EC (ATEX)	5
4	Technical data	5
5	Labeling on the device.....	6
5.1	Labeling on the device for explosion risk areas (ATEX).....	6
6	Construction and function.....	6
6.1	Overview	6
6.2	Description of function	6
6.3	Description of components	6
6.4	Accessories.....	7
7	Transport	7
7.1	Safety.....	7
7.2	Transport inspection	7
7.3	Storage	7
8	Assembly/Installation.....	7
8.1	Safety.....	7
8.2	Preparations (requirements for the installation location)	7
8.3	Assembly/Installation	7
8.4	Starting up.....	8
8.5	Subsequent relocation of the diaphragm seal assembly (by the customer).....	8
9	Servicing.....	8
9.1	Safety.....	8
9.2	Check on function	9
9.3	Cleaning and maintenance	9
10	Faults	9
10.1	Safety.....	9
10.2	Conduct in the event of faults	9
10.3	Fault table	9
10.4	Conduct following fault rectification	9
11	Demounting, disposal	9

11.1	Safety.....	9
11.2	Demounting.....	9
11.3	Disposal	9
12	Appendix	10
12.1	Declaration of conformity	10
12.2	Data sheets for diaphragm seals	11

1 General remarks

1.1 Purpose of this Manual



This Operating Manual contains fundamental and essential advice to be followed for the installation, operation and servicing of the device. It must be read without fail before assembly and start-up of the device by the fitter, the operator and the specialist personnel responsible for the device. This Operating Manual must be available at the point of use of the device at all times.

The following sections about general safety information (2) and also the following specific advice regarding the intended purposes (2.2) and through to disposal (11.3) contain important safety information which, if not followed, may result in risks for people and animals, or to property and buildings.

1.2 Symbols



Warning!

This indicates a possibly hazardous situation where failing to follow advice may result in risks to people, animals, the environment and buildings.



Information!

This emphasizes key information for efficient, fault-free operation.

1.3 Limits of liability

Failure to respect this safety information, the envisaged uses or the limit values relating to use indicated in the technical data for the device may result in risk or to injury to people, the environment or the plant.

Claims for compensation for damage against the device supplier are excluded in such an eventuality.

1.4 Copyright

This Operating Manual may only be copied and passed on as a complete document without the special permission of the publisher.

1.5 Warranty

For the product described here, we offer a warranty in accordance with Section 6 'Guarantee in Respect of Defects' in our General Terms and Conditions of Delivery and Payment.

1.6 Manufacturer's address, customer services

Ashcroft Instruments GmbH
 Max-Planck-Strasse 1
 D-52499 Baesweiler. Germany

Tel.: +49 (0) 2401/808-888
 Fax: +49 (0) 2401/808-999
 E-mail: customer.service@ashcroft.com
 Web: www.ashcroft.eu

2 Safety

2.1 General sources of hazards

Diaphragm seals, as a component of pressure measurement instruments, are pressurized parts where failure can result in hazardous situations. The choice of pressure gauge should be made in accordance with the rules set out in EN 837-2.

2.2 Use in accordance with intended purpose

The devices are only to be used for the intended purpose as described by the manufacturer.

The devices serve to separate the pressure measurement instrument and the process fluid.

For each use scenario, the corresponding set-up regulations must be respected. If used in explosion risk areas, the following conditions are to be respected.

2.3 Operator's responsibility

Safety instructions for proper operation of the device must be respected. They are to be provided by the operator for use by the respective personnel for installation, servicing, inspection and operation. Risks from electrical energy and from the released energy of the medium, from escaping media and from improper connection of the device must be eliminated. The details for this are to be found in the correspondingly applicable sets of regulations, such as DIN EN, UVV (accident prevention regulations) and in sector-specific instances of use (DVWG, Ex- GL, etc.), the VDE guidelines and the regulations supplied by local utilities companies.

The device must be taken out of service and secured against inadvertently being restarted, if the presumption is that risk-free operation is no longer possible (see Chapter 10: Faults).

Conversion works or other technical alterations to the device by the customer are not permitted. This also applies to installation of spare parts. Possible conversions or alterations may only be carried out by the manufacturer.

The operational safety of the device is only guaranteed where it is used for its intended purpose. The specification of the device must be adapted to the medium used in the plant. The limit values indicated in the technical data must not be exceeded.

The safety information detailed in this Operating Manual, existing national regulations for accident prevention, and the operator's internal regulations regarding working, operations and safety must be respected.

The operator is responsible for all specified servicing, inspection and installation works being carried out by authorized and qualified specialists.

2.4 Staff qualifications (target group assessment)

The device may only be installed and started up by specialist staff who are familiar with installation, start-up and operation of the product.

Specialist staff are people who are able to assess the work assigned to them on the basis of their specialist training, their knowledge and experience and their knowledge of the relevant standards, and can identify possible risks.

For devices in an explosion-protected finish, these staff must have been trained or instructed in, or be authorized for, working on explosion-protected devices in potentially explosive plants.

2.5 Signs/Safety markings

The diaphragm seal assembly and its surrounding packaging carry markings. These show the article number, the material of the parts in contact with the medium, the measurement range and manufacturer. The diaphragm seal assembly can be provided with additional signs and safety markings advising on special conditions:

- Advice on the filling liquid
- Advice on calibration
- Ex (for ATEX finish)
- Oil-can deleted (if cleaned for oxygen use)
- Advice on special cleaning (e.g. silicone-free)

2.6 Safety equipment

This device may be fitted with electrical earthing. A protective cover or cap prevents the diaphragm from damage during transport and storage.

2.7 Environmental protection

When mounted, this device contains a filling liquid (e.g. glycerin or silicone oil). The provisions set out in the REACH regulation on production and use of chemicals are to be respected, and the relevant safety data sheets from the manufacturers of the chemicals are available on our website for download.

3 Use in explosion risk areas in accordance with Directive 2014/34/EU (ATEX)

Area of use:

Explosion risk areas Zone 1 and 2, and 21 and 22, risk from gases and dry dusts.

Permitted temperatures:

The transfer fluids used as standard – glycerin, silicone oil and halocarbon – have an inflammation temperature that is 50 K above the maximum process fluid temperature specified in the diaphragm seal data sheet and for other transfer fluids the maximum process fluid temperature is determined by (inflammation temperature - 50 K).

Filler fluid	Coding	°C	°F
Glycerin	CG	-18 ... 205	0 ... 400
Silicone oil	CK/EJ	-40 ... 315	-40 ... 600
Halocarbon	CF	-57 ... 150	-70 ... 300
Syltherm 800	HA	-40 ... 350	-40 ... 660
Vegetable oil	GZ	0 ... 70	32 ... 158

Table 1

For diaphragm seal with special material diaphragm or coated diaphragm the maximum media temperature published with the data sheet has to be respected.

Grounding:

The membranes separating the process fluid from the pressure measurement device come in a wide variety of material finishes.

Since the electrically non-conductive membranes are held in electrically-conductive metal and are smaller than 100 mm in diameter, the permitted designed area of 80 cm² is not exceeded. With coated, non-conductive membranes having a larger area, the coating thickness may be a maximum of 0.2 mm and grounding must be provided via a grounding screw.

For the non-electrical part of the devices, the standards EN 13463-1 and EN 13463-5 are applicable with regard to explosion protection. The relevant requirements of these standards are satisfied.

The documentation has been filed with TÜV-Nord-Cert (see declaration of conformity).

Labeling:

CE  II 2 GD c II TX

Labeling for small devices:

CE  cX

4 Technical data

The detailed technical information can be found in the documents in the Appendix, Chapter 12.

5 Labeling on the device

The label with the serial number and type designation is located on the top section of the diaphragm seal. The materials identifier is encoded in the type designation.

5.1 Labeling on the device for explosion risk areas (ATEX)

The engraved label (for small devices) with the marking for explosion risk areas is located on diaphragm seal.

Type designation

##=D#-###=ATEX,

##=5##-###=ATEX

6 Construction and function

6.1 Overview

- 1 Pressure measurement instrument
- 2 Transfer fluid
- 3 Diaphragm seal
- 4 Diaphragm
- 5 Process connection

Figure 1

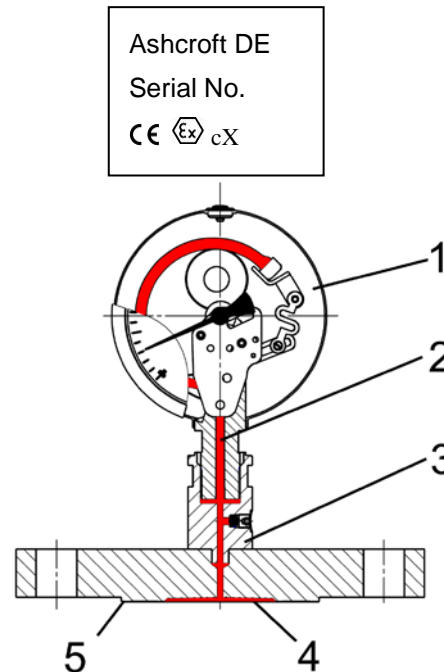

6.2 Description of function

A diaphragm seal is a device pre-mounted on the process side of a pressure measurement instrument and separating the device from the process fluid. All wetted parts of the diaphragm seal have to be compatible to the process media. The volume enclosed by the diaphragm, the top section of the diaphragm seal, the (optional) capillary line/cooling element and the measuring component of the pressure gauge is completely filled with a pressure transfer fluid suitable for this application. A change in pressure at the process connection causes a displacement of the filling fluid due to the deflection of the diaphragm, which transfers the change in pressure to the measuring component of the pressure measurement instrument.

6.3 Description of components

6.3.1 Diaphragm seal bottom section

The bottom section of the diaphragm seal serves to connect the seal to a pipe or tank, and its interior space is filled with the process fluid. In accordance with the installation conditions, the connection is provided via a screw, flange, clamp or welded connection. The bottom section of the diaphragm seal can optionally be fitted with one or two flushing connections. On front-flush diaphragm seals, this component is not required.

6.3.2 Diaphragm

The diaphragm separates the process fluid and the filling fluid. In the event of a change in pressure, it is deflected by the displacing filling fluid, and for this the maximum displacement volume of the diaphragm seal and the pressure measurement instrument must be matched with one another. The membrane is finished as a metal film, can be coated optional with another material and is welded into the top housing of the diaphragm seal.

6.3.3 Diaphragm seal top housing

The top housing of the diaphragm seal is used to connect to the pressure measurement instrument. On front-flush diaphragm seals, the process connection is also provided by the top section of the diaphragm seal. The filling connection in the top housing of the diaphragm seal is sealed with a pressure seal via a ball bearing in the conical seat, secured using a screw.

6.3.4 Transfer fluid

The transfer fluid hydraulically transfers the process fluid pressure from the diaphragm to the measuring component of the pressure measurement instrument.

6.4 Accessories

If the pressure measurement instrument and diaphragm seal are not directly mounted, in most cases a capillary line is used. It simultaneously serves, like the cooling element, to provide thermal decoupling of the gauge and diaphragm seal. Front-flush diaphragm seals can be fitted with a flushing ring, equipped with pipe adapters or with a drain plug. Please contact the manufacturer regarding special tools and accessories.

7 Transport

7.1 Safety

The diaphragm seal assembly should be protected against the effects of knocks and impacts. The device should only be transported in the packaging provided, to protect against glass breakage. The device should only be transported in a cleaned condition (free from process fluid residues).

7.2 Transport inspection

The delivery is to be checked for completeness and damage during transport. In the event of damage during transport, the delivery is not to be accepted, or only accepted subject to reservation of the scope of the damage being recorded and, if necessary, a complaint initiated.

7.3 Storage

The diaphragm seal assembly is to be stored in dry, clean conditions, within a temperature range of -40 to +60 °C, protected against direct exposure to sunlight and protected against impact damage.

8 Assembly/Installation

8.1 Safety

To ensure safe working during installation and servicing, suitable shut-off fittings are to be installed in the plant (see 6.4 Accessories), enabling the device:

- To be depressurized or taken out of operation;
- To be disconnected from the mains supply for repair or checks within the relevant plant;
- Or to enable function tests of the device to be performed “on site”.

During the works to mount/install the diaphragm seal assembly, the plant must be protected against being switched back on.

8.2 Preparations (requirements for the installation location)

- A check on suitability of the device and of the internal pressure transfer fluid for the medium to be measured, the scope of the measurement range and the extent of the protection against special conditions such as vibrations, pulsations and pressure blows.
- A bracket must be installed to support the pressure measurement instrument if the metered line is not able to provide adequate support.
- The installation location should be chosen such that the work-spaces for operating personnel are not located to the rear of the pressure measurement instrument.

8.3 Assembly/Installation

- The diaphragm seal is intended for direct assembly.
- The filled and calibrated diaphragm seal/pressure measurement instrument system must not be dismantled or altered.
- The seal on the filling screw must not be broken.
- The diaphragm must not be damaged, and scratches or indentations impair function and are points of attack for corrosion.

- Capillary lines must not be bent to have sharp edges (minimum bend radius 40 mm), and excess length is to be coiled using a radius of approx. 25 cm. The diaphragm seal must not be supported using the capillary line.
- Run the capillary line such that it is not exposed to any extreme temperatures and is protected against oscillations.
- Unless otherwise indicated, the diaphragm seal with capillary line and pressure measurement instrument are calibrated for installation at the same height. In the event that different height levels apply, the influence of hydrostatic pressure is to be respected, and collapse of the filling fluid column due to excessive height differences must be avoided (for glycerin and silicone oil max. 7 m, for halocarbon max. 4 m).
- Run capillary lines for differential pressure measurement instruments parallel as far as possible, to avoid temperature errors.

8.3.1 Process connection

- Connection only to be undertaken by authorized and qualified specialist staff.
- Use only with the mechanical process connection provided – regarding the finish, see order code on the device type label, with a matching threaded seal or flange seal.
- When connecting the device, the pipes must be depressurized.
- The pressure metering pipe is to be laid inclined in such a way that, for example, for measurements of fluids no air-pockets can form, and for measurements of gases no water-pockets. If the necessary incline is not achieved, then at suitable points water separators or air separators are to be installed.
- The pressure metering pipe is to be kept as short as possible and laid without sharp bends, to avoid the occurrence of irritating delays.
- With liquid process media, the pressurized connection pipe must be degassed, since any gas bubble inclusions result in measurement error.
- If water is used as the process medium, the device must be frost-protected.



Safety notice: Only mount using the correct open-jawed wrench, only use the wrench on the surfaces on the bottom section of the diaphragm seal and do not twist the device itself.

8.3.2 Grounding

For the grounding that may be necessary, an external connection to ground for fine-wire conductors up to 4 mm² or single-wire conductors up to 6 mm² is provided.



8.4 Starting up

The precondition for start-up is proper installation of all electrical lines and metering lines. All connecting pipes must be laid such that no mechanical forces can act on the device.

Before start-up, the seal on the pressurized connection line must be checked.

8.5 Subsequent relocation of the diaphragm seal assembly (by the customer)



Recommendation: Do not remove the pressure measurement instrument from one metering point and fit it in a different place, as there is a risk of the process fluids being mixed, with unforeseeable chemical reactions.

9 Servicing

The device does not require servicing under most conditions for use. However, to ensure reliable operation and a long lifetime for the device, we recommend that it is checked regularly.

9.1 Safety

When undertaking servicing work on the device, the pressure lines must be depressurized and the plant secured against being switched on again.

9.2 Check on function

The check on function is carried out at regular intervals, depending on the application. The precise testing cycles should be adjusted in line with the operating conditions and ambient conditions. In the event of various device components interacting, the operating instructions for all other devices should also be taken into account.

- Check on function, in conjunction with downstream components.
- Check on the diaphragm seal assembly and on pressurized connection lines for seal.
- Check of electrical connections.

9.3 Cleaning and maintenance

Cleaning is undertaken using a non-aggressive solvent and a suitable cleaning tool, and while doing so the diaphragm seal membrane is to be protected against damage.

10 Faults

10.1 Safety

Defective or faulty diaphragm seal assemblies put the operational safety and process safety of the plant at risk, and can lead to a risk or injury to persons, the environment or the plant.

10.2 Conduct in the event of faults

All defective or faulty devices are to be taken out of service. If a repair is required, the device is to be sent directly to our Repairs Department. We request that all returns of devices are agreed with our Service Department.

10.3 Fault table

Possible situations indicating a fault:

- Instrument indication or output signal does not follow process changes
- Jerky change to the display or output signal
- Large time delay on the pressure measurement instrument
- Damage to the diaphragm or housing through mechanical influence or corrosion
- Blocked or obstructed process connection
- Indications of a leak on the measuring system
- Bends on the capillary line
- Extended storage at temperatures above 60 °C

In these instances, replacement of the diaphragm seal/pressure measurement instrument system is always required.

10.4 Conduct following fault rectification

See Chapter 8 Mounting/Installation

11 Demounting, disposal

11.1 Safety



Residues of process fluid in and on removed diaphragm seal assemblies can constitute a risk to people, the environment and equipment. Adequate precautionary measures are to be adopted. If necessary, the devices are to be cleaned thoroughly (see advice in safety data sheets).

11.2 Demounting

- When undertaking servicing work on the device, the pressure lines must be depressurized and the plant secured against being switched on again.
- Demount the diaphragm seal assembly using a suitable tool









11.3 Disposal



Please help to protect the environment and dispose of or recycle the devices and components used in accordance with the applicable regulations.

12 Appendix

12.1 Declaration of conformity

	EU-Konformitätsbescheinigung EU-Declaration of Conformity <small>DIN EN ISO IEC 17050-1:2010</small>	
Ashcroft Instruments GmbH Max-Planck-Straße 1 52499 Baesweiler		
erklärt in alleiniger Verantwortung, dass die mit CE gekennzeichneten Produkte <i>declares in sole responsibility that the products marked with CE</i>		
Gerät: <i>Equipment:</i>	Druckmittler Typ 5XX und DX inklusive Zubehör wie Kühlelement, Spülring mit und ohne Stopfen und Kapillarleitung <i>Seals Type 5XX and DX included accessories such as Cooling element, Flushing rings with and without plug and Capillary.</i>	
Kennzeichnung: <i>Marking :</i>	  II 2 GD c II TX	
Kennzeichnung für kleine Bauteile: <i>Marking for small components:</i>	  cX	
Herstellungsdatum: <i>Date of manufacture:</i>	ab 20.04.2016 <i>from 20.04.2016</i>	
die grundlegenden Sicherheits- und Schutzanforderungen erfüllen, in Übereinstimmung mit den unten genannten Richtlinien und Normen. Die Konformitätsaussage bezieht sich auf die Konzeption und Fertigung der oben genannten Produkte. <i>the fundamental safety and protection requirements passed in accordance with the guidelines and standards listed below. This declaration of conformity refers to the design and manufacture of the above products.</i>		
Richtlinie <i>Directive</i>	2014/34/EU „Geräte und Schutzsysteme zur bestimmungsgemäßen Verwendung in explosionsgefährdeten Bereichen“ <i>“equipment and protective systems intended for use in potentially explosive atmospheres”</i>	
Angewendete harmonisierte Normen <i>Used harmonized Standards</i>	EN 13463-1:2009, EN 13463-5:2011	
Benannte Stelle <i>Notification Body</i>	Code number of notified Body: 0044 TÜV NORD CERT GmbH, Langemarckstr. 20, 45141 Essen	
Hinterlegungsnummer: <i>Dossier File No.:</i>	35101282	
Baesweiler, den 11.04.2016 Ort und Datum <i>Place and date</i>	 Werksleiter <i>Operation Manager</i>	
Ashcroft Instruments GmbH	Fon: +49 (0)2401-808-888	Fax: +49 (0)2401-7027
www.ashcroft.eu		
 		

12.2 Data sheets for diaphragm seals

Detailed data sheets are available directly from the manufacturer (see 1.6 Manufacturer's address, customer services)

The following table provides an overview of the individual documents:

Model	Description	Document
DF EN	Flush type flanged diaphragm seal according to EN 1092-1	G3.DF EN
DF ASME	Flush type flanged diaphragm seal according to ASME B16.5	G3.DF ASME
DFE EN	All welded flanged diaphragm seal with internal diaphragm according to EN 1092-1	G3.DFE EN
DFE ASME	All welded flanged diaphragm seal with internal diaphragm according to ASME B16.5	G3.DFE ASME
DT EN	Truncated type flanged diaphragm seal according to EN 1092-1	G3.DT EN
DT ASME	Truncated type flanged diaphragm seal according to ASME B16.5	G3.DT ASME
DS	Sandwich type flanged diaphragm seal	G3.DS
DST	Sandwich type flanged diaphragm seal with tubus extension	G3.DST
1115	Capillary line model 1115A/1115P	G3.1115
FR	Flushing ring model FR	G3.FR