

## Data Sheet

### Gauge Valve - V02 Series

#### FEATURES

- Isolates process from instrument assembly
- Stainless Steel 316L (1.4404) construction

#### TYPICAL USES

- Oil & Gas Industry
  - Upstream: Onshore/offshore production
  - Midstream: Transport, storage and natural gas compression
  - Downstream: Refineries and petrochemical industries
- Chemical Industry
- Power Plants
  - Conventional power plants
  - Flue gas desulfurization plants
- Other Industries
  - Waste incineration plants
  - Seawater desalination plants
  - Steel mills
  - Cement plants

**Style A**  
Gauge Valve

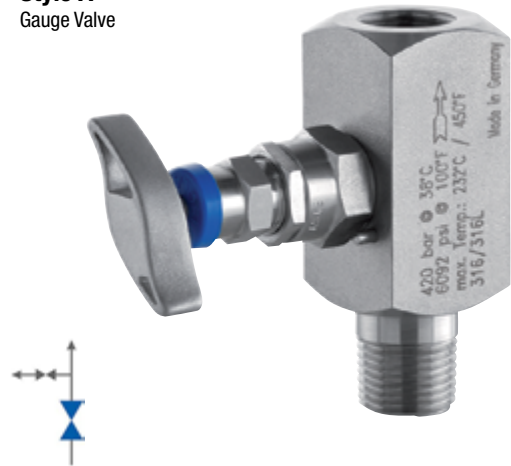

#### SPECIFICATIONS

Process Connection:	1/2 NPT Male, 1/2 NPT Female
Instrument Connection:	1/2 NPT Female
Construction:	Stainless Steel 316L (1.4404) Monel 400 (2.4360) Hastelloy C-276 (2.4819) others on request
Max. Pressure Rating:	420 bar at 38 °C (6092 psi at 100 °F) more details, check chart below
Max. Temperature Rating for:	
PTFE	232 °C (450 °F)
Graphite	550 °C (1.022 °F)
Oxygen service	200 °C (392 °F)
Min. Temperature Rating for:	
PTFE	-40 °C (-40 °F)
Graphite	-40 °C (-40 °F)

#### KEY BENEFITS

- Available for oxygen service
- Color-coded dust caps prevent dust ingress and identifies handle function
- PTFE Packing (other materials available upon request)
- Stem with cold rolled surface, back seat and non-rotating needle tip
- Supplied with wetted parts according to NACE MR0175/MR0103 (CD-5 Certificate)
- Material traceability reports available per EN 10204 3.1

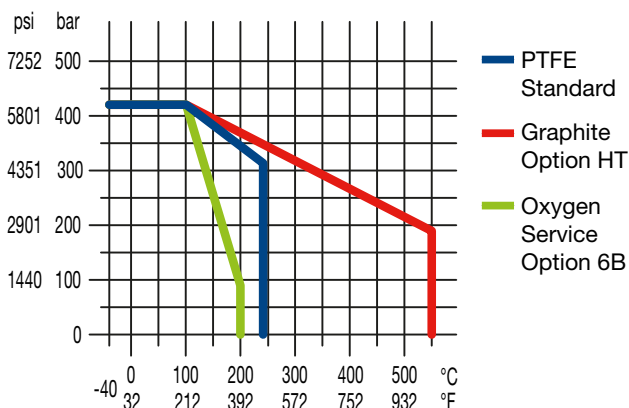

#### COMPONENTS

#### MATERIAL

##### Wetted

Body	316L (1.4404)
Valve stem	316L (1.4404)
Needle tip	316Ti (1.4571)
Packing	PTFE or Graphite
Gland nut	304 (1.4301)

##### Non-Wetted

Bonnet	316 (1.4401)
T-handle	316 (1.4401)

**Gauge Valve - V02 Series**
**DIMENSIONS IN MM [INCH]**

For reference only, consult Ashcroft for specific dimensional drawings

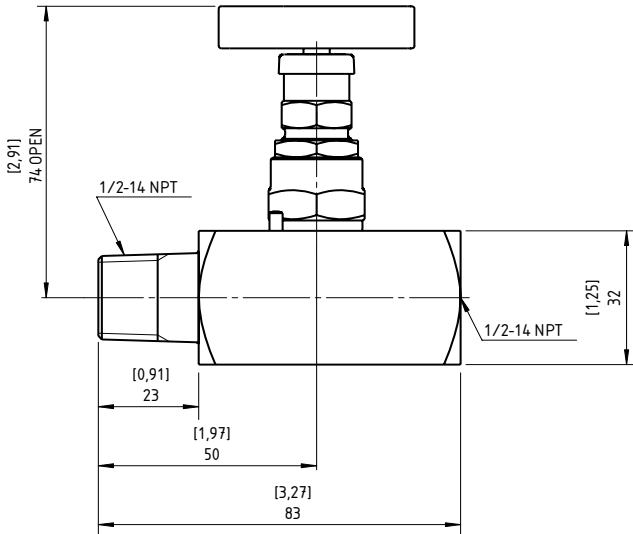
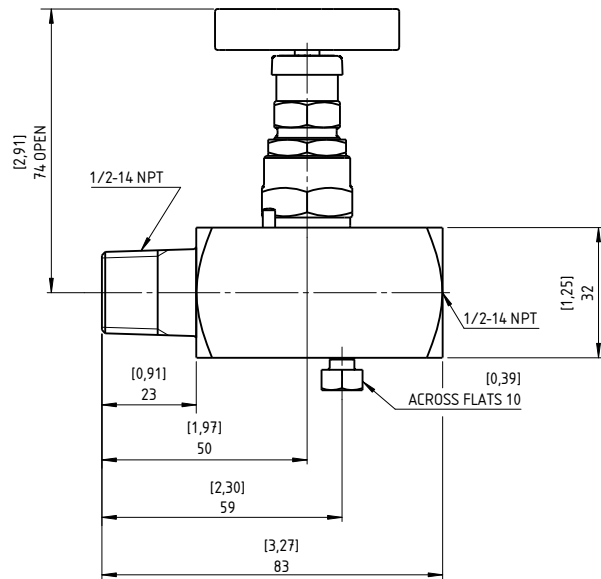
**Style A**

**Style B**
**OPTION TM - 2" PIPE MOUNTING BRACKET - DIMENSIONS IN MM [INCH]**

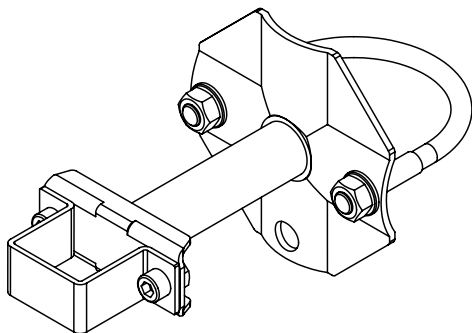
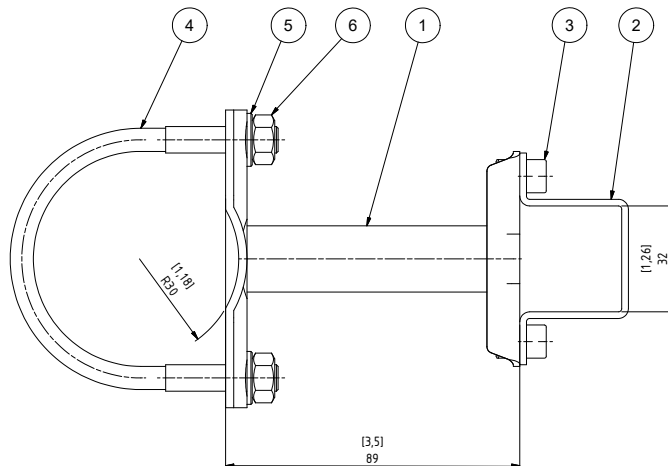
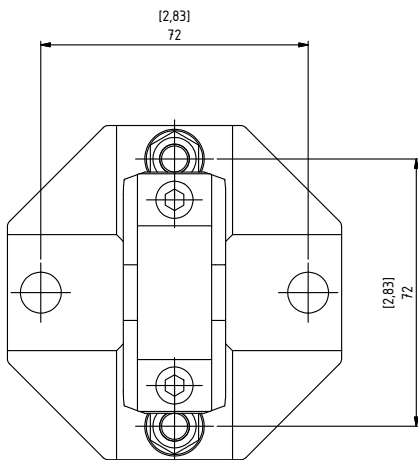
For reference only, consult Ashcroft for specific dimensional drawings



POS.	DESCRIPTION	MATERIAL
1	Mounting bracket	316Ti (1.4571)
2	Bracket	316Ti (1.4571)
3	Socket head cap screw ISO 4762 - M6x10	A4
4	U-bolt M8 for 2" pipe	A4
5	Washer 8,4 DIN 128-B	A4
6	Hexagon nut DIN EN 24032-M8	A4



# Data Sheet

## Gauge Valve - V02 Series

ORDERING CODE		EXAMPLE:	04	V02	1V	A	SS	50	HT
<b>Process Connection</b>									
04	1/2 NPT Male (style A only)		04						
50	1/2 NPT Female								
<b>Series Code</b>									
V02	Valve Series V02			V02					
<b>Valves</b>									
1V	1 Valve				1V				
<b>Version</b>									
A	Style A					A			
B	Style B (with vent screw)								
<b>Material</b>									
SS	Stainless steel 316L (1.4404)						SS		
PM	Monel 400 (2.4360)								
HH	Hastelloy C-276 (2.4819)								
<b>Instrument Connection</b>									
25	1/4 NPT Female								
50	1/2 NPT Female							50	
<b>Options (If choosing an option(s) must include a "X")</b>									
HT	Graphite bonnet for high temperature								HT
TM	Pipe mounting bracket								
QC	Arctic operations (-55 °C/-67 °F)								
C3	Material Traceability Report acc. to EN 10204 3.1								
CD5	Certificate according to NACE for Oilfields MR0175/ISO 15156-2009 and for Refineries MR0103-2010								
MQ	Positive Material Identification (PMI-Test)								
HY	Hydrostatic Testing								
P7	Power piping acc. to ASME B31.1								
PN700	High pressure (10.000 psi / 689 bar)								
6B	Cleaned for Oxygen Service								
NH	Stainless Steel Tags								

